

Electrifying diagrams for learning: principles for complex representational systems

Peter C.-H. Cheng*

*Department of Psychology, ESRC Centre for Research in Development, Instruction and Training,
University of Nottingham, University Park, Nottingham NG7 2RD, UK*

Received 19 September 2001; received in revised form 3 April 2002; accepted 20 June 2002

Abstract

Six characteristics of effective representational systems for conceptual learning in complex domains have been identified. Such representations should: (1) integrate levels of abstraction; (2) combine globally homogeneous with locally heterogeneous representation of concepts; (3) integrate alternative perspectives of the domain; (4) support malleable manipulation of expressions; (5) possess compact procedures; and (6) have uniform procedures. The characteristics were discovered by analysing and evaluating a novel diagrammatic representation that has been invented to support students' comprehension of electricity—AVOW diagrams (Amps, Volts, Ohms, Watts). A task analysis is presented that demonstrates that problem solving using a conventional algebraic approach demands more effort than AVOW diagrams. In an experiment comparing two groups of learners using the alternative approaches, the group using AVOW diagrams learned more than the group using equations and were better able to solve complex transfer problems and questions involving multiple constraints. Analysis of verbal protocols and work scratchings showed that the AVOW diagram group, in contrast to the equations group, acquired a coherently organised network of concepts, learnt effective problem solving procedures, and experienced more positive learning events. The six principles of effective representations were proposed on the basis of these findings. AVOW diagrams are Law Encoding Diagrams, a general class of representations that have been shown to support learning in other scientific domains.

© 2002 Cognitive Science Society, Inc. All rights reserved.

Keywords: Representations; Diagrams; Conceptual learning; Problem solving; Electricity; Task analysis; Science education

*Tel.: +44-115-9515330; fax: +44-115-9515324.

E-mail address: peter.cheng@nottingham.ac.uk (P.C.-H. Cheng).

1. Introduction

Finding a good representation may substantially improve our comprehension of a scientific domain, enhance our ability to reason and solve problems, and lead to better learning over traditional representations used for instruction. What makes a good representation for reasoning, problem solving and learning is an important question for cognitive science. Different representations of formally isomorphic problems can make a problem more than an order of magnitude harder to solve (Kotovsky, Hayes, & Simon, 1985). Diagrams are often good for reasoning and problem solving (e.g., Glasgow, Narayanan, & Chandrasekaran, 1995; Peterson, 1996). Larkin and Simon (1987) argue that the benefits of diagrams over sentential representations come from the use of the locational indexing of information that aids search for relevant information and the use of perceptual operators in recognition of information for inferences. The representations possessed by experts are central to their better organised and integrated knowledge, their better memory of their domains and their enhanced problem solving performance (e.g., Chi, Glaser, & Farr, 1988; Ericsson & Smith, 1991). Koedinger and Anderson (1990) have shown that the basis of the enhanced performance by expert geometry problem solvers over novices resides in their use of *diagrammatic configuration schemas*. Stenning and Oberlander (1995) argue that the *specificity* of a representation is important in the explanation of its effectiveness, or otherwise, and that diagrams are often good because they are systems with limited abstraction, being neither too abstract nor too specific.

Palmer (1978) considers how representations capture the constraints of the represented domain in order to understand the effectiveness of representations, i.e., whether properties inherent to the representation itself encode the constraints or whether logical rules are required to relate the constraints to the structure of the representation. More recently, the same issue has been cast in terms of the relation between the internal and external aspects of representations. Zhang and Norman (1994) consider the nature of external representations: they can be memory aids; they provide information that can be directly perceived and used without the need to be interpreted and formulated explicitly; they can anchor and structure cognitive behaviour; they may change the nature of the task; and, they are an indispensable part of the representational system of any distributed cognitive task. Zhang (1997) presents a theoretical framework that includes components for external and internal parts of the overall representational system and argues for a form of representational determinism, in which the nature of a representation determines what information can be perceived, what processes can be activated, and what structures can be discovered.

The work reported here is part of a programme of research that is studying the nature of representational systems for problem solving and learning in science and mathematics. It contrasts extant and standard representations with an interesting class of representations called Law Encoding Diagrams (LEDs). LEDs are representations that capture the laws or relations of a domain in the structure of a diagram using geometric, topological or spatial constraints, such that each instantiation of a diagram simultaneously represents one case of the laws and one instance of the phenomenon. Some important discoveries in the history of science were made using LEDs (Cheng, 1996a; Cheng & Simon, 1995). The cognitive benefits that the original scientists obtained working with LEDs may be conferred upon problem solvers and

learners who are studying the same scientific topic. LEDs have been adopted for the study of the nature of representations because they have interesting properties that are providing insights into the nature of representations in problem solving and learning (Cheng, 1996b, 1999a, 1999d).

This paper considers learning with a class of LEDs invented by the author to support the comprehension of electricity—AVOW diagrams (Amps, Volts, Ohms, Watts) (Cheng, 1999a, 2001). Comparisons of problem solving and learning with AVOW diagrams versus a conventional algebraic approach are presented, which demonstrate that AVOW diagrams constitute an effective representational system for comprehending electricity and solving circuit analysis problems at advanced high school level. By contrasting the reasons for the differences between the two systems, six characteristics of effective representational systems for learning have been formulated, which are introduced and discussed here.

The characteristics advance our understanding of the role of representational systems in learning, have potential utility in the analysis of extant representations and can support the design of effective novel representations for complex conceptual domains. Three of the characteristics address how the different aspects of the represented domain should be made readily apparent in the structure of an effective representational system. Such *semantic transparency* can be achieved by: (a) integrating within each expression in the representational system the different levels of abstraction present in the domain; (b) combining globally homogeneous representation of overarching conceptual dimensions with locally heterogeneous representation of low level conceptual distinctions; and (c) coherently integrating within the expressions of the representation the alternative perspectives that it is possible to hold of the domain. The other three characteristics concern how to improve the use and usability of a representation for generating expressions during problem solving by ensuring that the representation has an appropriate degree of generativity. Such *syntactic plasticity* can be achieved by: (a) making the expressions in the representation malleable, that is not too rigid nor too fluid; (b) having compact procedures for the transformation of expressions; and (c) having procedures that are uniform.

To introduce AVOW diagrams and the conventional algebraic approach, and also to begin to demonstrate the relative advantages of the two representations, a task analysis is first presented. A learning experiment that contrasts the two approaches is then described. The results consider both the overall pattern of learning gains and the detailed examination of verbal protocols and work scratchings. The following two sections then compare the different forms of support for learning that the two representations provide, from which the characteristics of effective representational systems are derived. Finally, the scope and limitations of LEDs as an effective approach to supporting science learning are discussed in relation to previous studies.

Different perspectives may be adopted for electricity instruction that emphasise causal relations, formal constraint-based relations or the integration of microscopic and macroscopic levels of description of the domain. AVOW diagrams can support all of these perspectives (Cheng, 2001). The conventional Equations approach is well suited to considerations of formal constraint-based relations but it provides no natural support for the other perspectives. Thus, the task analysis and experiment will take a perspective that concentrates on the formal relations to provide a constrained but common and fair basis for the study of the two representational systems.

2. Representations for electricity—task analysis

A summary of a task analysis of problem solving in electricity is presented to introduce AVOW diagrams, to review the conventional algebraic representation and to begin to examine the different properties of the two representational systems (for the complete analysis, see Cheng, 2000). After the introduction of the declarative knowledge and problem solving procedures, ideal solutions to a range of typical problems are presented. A bias towards the conventional algebraic representation was maintained throughout the analysis to provide a conservative basis for comparison of the benefits of AVOW diagrams over the Equations approach.

2.1. Declarative knowledge of the domain

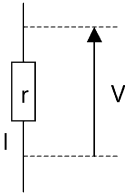
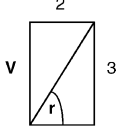
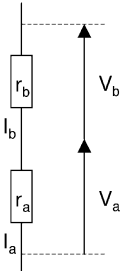
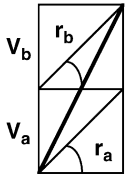
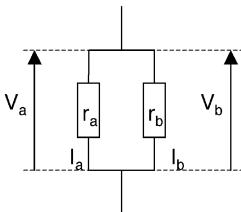
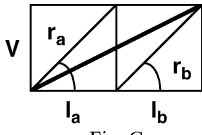
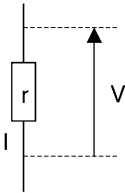

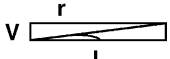
Tables 1 and 2 present a range of concepts concerning circuits and their behaviours. The basic properties of electricity are: current, I ; voltage (potential difference, electromotive force), V ; resistance, r ; and power, P . Under the conventional approach, symbols standing as variables for these properties appear in the algebraic formulas. In AVOW diagrams V , I , P and r are represented by the height, width, area and gradient (slope) of the diagonal, respectively. A particular drawing of an AVOW box represents a load with a particular set of values denoted by either drawing it to scale or attaching labels to particular features (e.g., Fig. A in Table 1). For a particular component, resistor/load or isolable sub-network in a circuit, the fundamental laws of electricity that interrelate these properties are Ohm's law and the Power law (Eqs. (1) and (2) in Table 1). There are separate equations for each law under the conventional approach but AVOW diagrams simultaneously encode both laws in a single simple visual form using the basic geometry of rectangles (i.e., these mappings apply: Ohm's law, height = width \times gradient $\Leftrightarrow V = I \times r$; Power law, area = height \times width $\Leftrightarrow P = V \times I$).

Loads and sub-networks may be connected together in series, parallel or both to make networks. Table 1 presents the formulas that model how the current is shared and how the voltage is distributed in simple series configurations (Eqs. (3)–(6)) and how voltage is shared and current is distributed in simple parallel configurations, Eqs. (7a)–(10). Also given are formulas for the overall resistance and power of such networks. Figs. B and C show how AVOW boxes can be assembled to model series and parallel networks, by stacking the boxes or placing them side-by-side. The sharing or distribution of voltage and current under the different circuit configurations is visualised by the heights and widths of these composite diagrams. The overall resistance and power of each pair of loads is given by the overall gradient of the diagonal and the overall area, respectively.

Properties of insulators and conductors are given in Table 1, either as eight equations (Eqs. (11)–(18)) or as two diagrams (Figs. D and E). They indicate that for both insulators and conductors the power consumed is small, but otherwise their properties are opposites. Taken to their extremes, AVOW boxes representing insulators and conductors tend to vertical or horizontal line segments, respectively. This provides a natural representation of conductors and insulators in circuits; for example, the wire connecting the two series resistors in Fig. B and the air between the two parallel resistors in Fig. C, respectively.


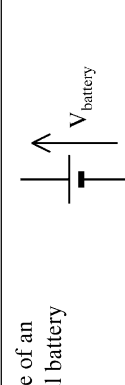

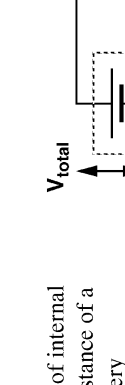

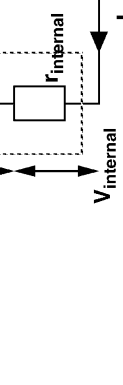
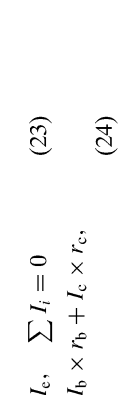
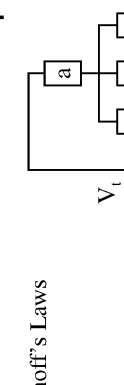
Table 2 considers batteries and further aspects of circuit behaviours. An ideal battery provides a constant potential difference. Under the algebraic approach the total voltage across the circuit

Table 1
Basic knowledge about electricity in terms of the two representations

Description	Network diagram	Equations	AVOW
A single load or isolable sub-network		Ohm's law : $V = I \times r$ (1) Power law : $P = V \times I$, or $P = I^2 \times r$ (2)	 Fig. A
Loads in series		$r_{total} = r_a + r_b$ (3) $V_{total} = V_a + V_b$ (4) $I_a = I_b$ (5) $P_{total} = P_a + P_b$ (6)	 Fig. B
Loads in parallel		$\frac{1}{r_{total}} = \frac{1}{r_a} + \frac{1}{r_b}$ (7a) $r_{total} = \frac{r_a r_b}{r_a + r_b}$ (7b) $V_a = V_b$ (8) $I_{total} = I_a + I_b$ (9) $P_{total} = P_a + P_b$ (10)	 Fig. C
Insulators and conductors		$r_{insulator} \approx \infty$ (11) $V_{insulator} \neq 0$, often large (12) $I_{insulator} \approx 0$ (13) $P_{insulator} \approx 0$ (14)	 Fig. D
		$R_{conductor} \approx 0$ (15) $V_{conductor} \approx 0$ (16) $I_{conductor} \neq 0$, often large (17) $P_{conductor} \approx 0$ (18)	 Fig. E

equals the battery voltage, Eq. (19). In an AVOW diagram the constant voltage of the battery is represented by a pair of horizontal lines (Fig. F) or by ensuring that all AVOW diagrams for networks connected to identical batteries are drawn with equal heights. Real batteries have some internal resistance, which must be taken into account in the analysis of circuits. In general, this is modelled by considering there to be an extra load directly in series with the battery. For the conventional approach this requires Eqs. (20)–(22) to be used to compute the effective voltages, currents and resistances of the circuit. Similarly, AVOW diagrams model

Table 2
Batteries and knowledge about circuit behaviours in terms of the two representations

Description	Network diagram	Equations	AVOW
Voltage of an ideal battery		$V_{\text{battery}} = V_{\text{circuit}} \quad (19)$	
Effect of internal resistance of a battery		$V_{\text{total}} = I_{\text{total}} \times r_{\text{internal}} + V_{\text{load}} \quad (20)$ $r_{\text{total}} = r_{\text{internal}} + r_{\text{load}} \quad (21)$ $I_{\text{total}} = I_{\text{internal}} + I_{\text{load}} \quad (22)$	
Kirchhoff's Laws		$I_a = I_b + I_d + I_c, \quad \sum I_i = 0 \quad (23)$ $V_t = I_a \times r_a + I_b \times r_b + I_c \times r_c, \quad (24)$ $V_t = \sum I_i \times r_i$	
Cut circuit (x) and short circuit (s)		<p>Cut : ignore sub-network containing the cut Short : ignore sub-networks in parallel with the short</p>	

such circuits by the inclusion of an AVOW box across the full width of the diagram to stand for the internal load. The shaded area in Fig. G indicates the rest of the (external) circuit.

Kirchhoff's laws are the fundamental laws of basic electricity, and can be used to analyse circuits irrespective of whether or not they are composed of sub-networks that are isolable. The laws encode the principles of: (a) current conservation at any node within a circuit, Eq. (23); (b) the distribution of voltages around any closed loop within a circuit, Eq. (24). Kirchhoff's laws are typically treated as an advanced topic in basic electricity texts, and for that reason omitted in some introductory courses. In AVOW diagrams, these laws are encoded by rules that a complete and correct AVOW diagram must be a rectangle with no overlapping boxes and no gaps between boxes (e.g., Fig. H).

Under the Equations approach short circuits and broken circuits are treated differently from normally operating circuits. When such problems occur the affected parts of the circuit are ignored and the circuit re-analysed. In these situations the AVOW diagrams are no different to normal AVOW diagrams, the short circuit or the broken circuit are simply represented as conductors or insulators, tall–thin or flat–wide AVOW boxes, respectively, as shown in Fig. I.

2.2. Procedural knowledge for problem solving

The substantial differences in the way these two representations capture the knowledge of the target domain have corresponding differences in the way reasoning and problem solving is done. For basic electricity problem solving under the Equations approach, modelling the problem situations by writing and manipulating formulas is fundamental. The equation writing (EW) classes of procedures typically used are:

- EW1 Select and write an equation for a given problem situation (e.g., given a pair of loads in series write $r_{\text{total}} = r_a + r_b$).
- EW2 Substitute one equation into another (e.g., $V = I \times r$ into $P = V \times I$ gives $P = I^2 \times r$).
- EW3 Simplify an expression (e.g., $V_t^2 R_i / 2(R_i/2 + R_i)^2 = V_t^2 / 4.5 R_i$) or rearrange an equation to isolate a term (e.g., $P = V \times I \Rightarrow V = P/I$).
- EW4 Apply result derived for one case to a related situation (e.g., given a formula for a two-resistor configuration write an expression for an equivalent three-resistor configuration).
- EW5 Choice of a special solution strategy (e.g., simultaneous equations).
- EW6 Generate a set of equations containing multiple terms that are not redundant (e.g., set up unique simultaneous equations).
- EW7 Choice of one equation from many where substantial look ahead is required (e.g., as required for the completion of an extended sequence of manipulations).

In addition to the procedures for modelling problem situations, other procedures are required to interpret the models and to apply them to the specifics of a problem. The equation interpretation (EI) procedures typically used are:

- EI1 Substitute given problem values into an equation and, if required, calculate values (e.g., $r_{\text{total}} = r_a + r_b$, $r_a = 1$, $r_b = 2$, $r_{\text{total}} = 1 + 2 = 3$).

- EI2 Compare values (e.g., $V_a = 9I_t \times r_c$, $V_b = 4I_t \times r_c$, so $V_a > V_b$)
- EI3 Infer a relation from a simple formula (e.g., $V_{\text{total}} = V_a + V_b$ implies V_a decreases as V_b increases).
- EI4 Interpret a complex formula (e.g., when variables tend to infinity in the denominator term of a formula involving a quotient expression).
- EI5 Find a relation by comparing across two or more formulas.

Modelling typically begins with the recall or selection of relevant equations, such as those in [Tables 1 and 2](#), on the basis of the available information about known and unknown properties, and the configuration of the given circuit. The chosen equations are then manipulated so that desired relations can be found, or quantitative values computed. The general strategy adopted will depend upon the form of the equations present, the techniques available to the problem solver, and the specific goals. Some of the general (G) classes of procedures that deal with the strategic aspects of problem solving are these:

- G1 Determine whether a circuit is comprised of fully isolable sub-networks.
- G2 For a decomposable circuit plan a recursive analysis sequence.
- G3 Re-conceptualise and re-draw the structure of a complex circuit (e.g., change a 3D image into a 2D layout).
- G4 Assume behaviour of part of circuit (e.g., direction of current flow).
- G5 Heuristic iteration over cases to find values/configurations to satisfy given constraints (e.g., solution by successive approximations).

A common technique in the analysis of electrical circuits is to decompose the network of loads into sub-networks that are isolable, groups of resistances that are purely in series or in parallel with each other. The properties of such sub-networks are then computed in isolation and the new group treated as if it were a single load within a larger sub-network, in a recursive fashion. For complex circuits, deciding whether or not the network is so decomposable (G1) and planning the sequence of analytic steps (G2) are important initial stages in problem solutions. When the decomposition strategy is not feasible, weak methods or knowledge-based approaches can be used; for example, the use of trial and error search (G4 and G5) or attempting to simplify the structure of the circuit (G3). These strategic procedures are applicable under both approaches.

The procedures specific to problem solving with AVOW diagrams have been developed as an integral part of our work with this novel representational system ([Cheng, 1998, 2001](#); [Cheng & Shipstone, in press, a, in press, b](#); [Shipstone & Cheng, 2001, 2002](#)). As with the Equations approach, the AVOW diagram procedures approach can also be split into generative and interpretive procedures. The AVOW diagram drawing (AD) procedures to generate and manipulate diagrams are:

- AD1 Draw a component, or set of components treated as a whole unit, that just needs to be scaled and positioned (e.g., for simple series circuit draw [Fig. B, Table 1](#)).
- AD2 Transform an existing diagram component to satisfy problem constraints, where the relative sizes of the components must be adjusted (e.g., apply diagonal intersection technique, [Fig. 1a](#))

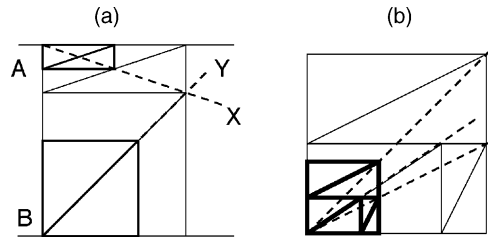


Fig. 1. Two geometric construction techniques for AVOW diagrams.

- AD3 Re-scale whole or part of an existing diagram (e.g., apply the geometric scaling technique, Fig. 1b).

Modelling involves drawing an AVOW diagram with a spatial layout matching the topology of the circuit. Depending on the nature of the circuit, the problem goal and user's experience, different approaches to drawing may be taken. For example, it is possible to assemble an AVOW diagram in a piecewise fashion by incrementally using the patterns for series and parallel networks given in Table 1. Alternatively, one might draw a large rectangle for the outline of the complete AVOW diagram and then subdivide it with horizontal and vertical lines for series and parallel sub-networks. Simple geometric constructions are typically sufficient, but two slightly more complex but useful techniques are shown in Fig. 1. In Fig. 1a two AVOW boxes with fixed gradients (known resistance) must be stacked within a given overall height (in series with a known voltage). This is done by finding the intersection of diagonals X and Y, which gives the relative sizes of the two boxes. Fig. 1b shows how the size of an arbitrary diagrammatic configuration can be simply changed by geometric scaling. Most AVOW diagrams can be constructed using techniques that are no more complex than these. The classes of AVOW diagram interpretive (AI) procedures are:

- AI1 Fill in values of an AVOW box, overall composite or parts of a composite using simple calculations (e.g., sum widths, heights or areas).
- AI2 Proportional calculation to compute values of an AVOW box, or whole composite (e.g., given gradient and area, find height and width).
- AI3 Composite calculation to find value of parts of composite using calculations that co-ordination across more than one AVOW box or sub-network (e.g., given Fig. B, total voltage, r_a and r_b , find V_a and V_b).
- AI4 Compare sizes of features, boxes or diagrams (e.g., Compare r_a and r_b in Figs. B and C) or infer relations (e.g., total r in Fig. C (Table 1) decreases as r_a or r_b increases).

To encode magnitudes of properties, AVOW diagrams may be drawn to scale or simple geometrical and proportional reasoning can be used to infer values associated with particular features of AVOW boxes. Qualitative reasoning is typically done by comparison of the structure, shape and size of visual features of the diagrams. In some cases it is possible to read solutions directly from an AVOW diagram drawn straight from a problem statement, but in other cases

Table 3
Representative electricity problems

Problem	Description
1. Single load	Find r and P given magnitudes of V and I ; and find V and I given P and r .
2. Series network	Find V , I , P for each of the two loads in series and for the whole network given the resistance of each load.
3. Parallel network	Find V , I , P for each of the two loads in parallel and for the whole network given the resistance of each load.
4. Composite	Find the power dissipated by a network, with isolable sub-networks, connected to a battery with a known voltage.
5. Blown bulb	Analyse a circuit of three bulbs when one of them burns out.
6. Resistance matching	What should the resistance of a load be to maximise its power when it is directly connected to a battery with an internal resistance?
7. Ideal and real batteries	When one, two or three batteries are connected across a real battery, why does their brightness change but when connected to an ideal battery there is no change?
8. Short circuit	What happens to the power dissipated in a load and a real battery when a short circuit occurs?
9. Wheatstone bridge	What is the overall resistance of a Wheatstone bridge?
10. Cube of bulbs	What is the overall resistance of a “Cube” of bulbs (Fig. 4)?

modifications to the initial diagram may be required, using weak methods or knowledge-based techniques (G3–G5).

2.3. Task analysis of typical problems

The declarative knowledge and procedures for the two approaches to electricity have been used to generate ideal solutions to the 10 problems, listed in Table 3. They range from simple computations to problems that require a good conceptual understanding of the domain to solve. All are typical problems from advanced high-school science courses that deal with electricity (e.g., Breithaupt & Dunn, 1983; Duncan, 1973; Hewitt, 1992; Pople, 1996). They were also used in the exercises and tests in the experiment presented below. The solutions to the problems used the contents of Tables 1 and 2 and the classes of procedures given above (EW, EI, AD, AI, G).

In the solutions, short cuts were used where appropriate within the Equations approach; for example, in a particular problem, if an equation has been solved once and there is a structurally equivalent equation, then its solution is simply written by substituting the relevant variables into the first solution. In addition to considering the number of procedures used, the analysis also considered solution *steps*, which are sets of procedures that good problem solvers could easily perform as a single short coherent sequence. To provide a stringent test of the relative merit of AVOW diagrams, most uses of the procedures with AVOW diagrams solutions were counted as a single step, but for the algebraic approach procedures were aggregated into a single step

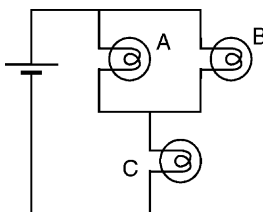


Fig. 2. A network of light bulbs.

whenever they could possibly have been done together, say by a particularly capable student. Two of the problems, (5) Blown bulb and (10) Cube of bulbs, are considered in detail to illustrate the analysis.

2.3.1. Blown bulb

This problem concerns the circuit shown in Fig. 2, in which all the bulbs are identical. What will happen to the relative brightness of the bulbs when bulb A burns out (becomes an insulator)? This problem is interesting because it is deceptively difficult. It requires: (a) the initial operating state of the circuit to be determined; (b) the final operating state to be determined after the fault occurs; and (c) the comparison of the appropriate parts of the initial and final states. Few people are able to correctly reason through this problem without the use of an external representation, as many inferences involving multiple constraints have to be performed, which impose a large cognitive load.

Table 4 shows the 14 inference steps in an ideal solution to the problem using the algebraic representation. Steps 1–7 produce equations for the power dissipated in each of the bulbs with the circuit operating normally. This involves selecting and manipulating appropriate equations to model the given circuit configuration under the condition that all the bulbs have equal resistances. Similarly, in Steps 8–13, equations for the power in the two good bulbs are derived assuming that the Blown bulb can simply be ignored, because it is an insulator. Most steps in the solution include several procedures. The last row of the table gives the average number of procedures per step and also the total number of knowledge steps that involved the use of an item from Table 1 or Table 2.

The AVOW diagram solution to the same problem is shown in Fig. 3 and the steps summarised in Table 5. First, a diagram (Fig. 3a) is drawn for the good circuit in one step, because

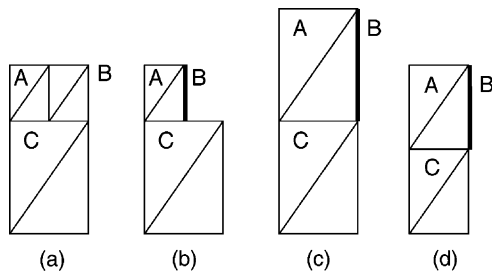


Fig. 3. Solution to the Blown bulb problem using AVOW diagrams.

Table 4
Solution to the Blown bulb problem using the algebraic approach

Steps	Procedure	Equations used
Let $r = r_A = r_B = r_C$		
1. Before: circuit working normally $r_t = \frac{r_A r_B}{r_A + r_B} + r_C = \frac{r_A r_B + r_A r_C + r_B r_C}{r_A + r_B} = \frac{3}{2r}$	EW1, EW1, EW2, EW3, EI1	(3), (7)
2. $I_B = \frac{I_t}{2} = \frac{V_t^2}{2r_t} = \frac{V_t^2}{3r}$	EW1, EW2	(9), (1)
3. $P_B = I_B^2 r_B = \left(\frac{V_t}{2r_t}\right)^2 r_B = \left(\frac{V_t}{4r_t^2}\right) r_B$ $= V_t^2 r_B \frac{[(r_A + r_B)/(r_A r_B + r_A r_C + r_B r_C)]^2}{4} = \frac{V_t^2}{9r}$	EW1, EW1, EW2, EW3, EW2, EI1	(2), (1)
4. Similarly, $P_A = \left(\frac{V_t}{4r_t^2}\right) r_A = \frac{V_t^2}{9r}$	EW4	
5. $I_C = I_t = \frac{V_t}{r_t} = \frac{2V_t}{3r}$	EW1, EW2	(1)
6. $P_C = I_C^2 r_C = \left(\frac{V_t}{r_t}\right)^2 r_C = \left(\frac{V_t^2}{r_t^2}\right) r_C$ $= V_t^2 r_C \left[\frac{r_A + r_B}{r_A r_B + r_A r_C + r_B r_C} \right]^2 = \frac{4V_t^2}{9r}$	EW1, EW1, EW2, EW3, EW2	(2), (1)
7. $P_A = \frac{V_t^2}{9r}, P_B = \frac{V_t^2}{9r}, P_C = \frac{4V_t^2}{9r}$	EI2	
8. After: cut circuit, ignore r_A, r_B and r_C in series	G3	(26)
9. $r_t = r_B + r_C$	EW1	(3)
10. $I_B = I_t = \frac{V_t}{r_t} = \frac{V_t}{r_B + r_C} = \frac{V_t}{2r}$	EW1, EW2, EI1	(1)
11. $P_B = I_B^2 r_B = \frac{V_t^2 r_B}{(r_B + r_C)^2} = \frac{V_t^2}{4r}$	EW1, EW2, EI1	(2)
12. Similarly, $P_C = \frac{V_t^2}{4r}$	EW4	
13. $P_B = \frac{V_t^2}{4}, P_C = \frac{V_t^2}{4}$	EI2	
14. Compare powers before and after	EI2	
Procedures per step, knowledge steps	2.4	9

the configuration is simple and all the gradients are equal. The diagram is then re-drawn with the Blown bulb shown as an insulator (Fig. 3b) and the whole diagram re-drawn so that overall it is a complete rectangle (Fig. 3c). This diagram is then re-scaled so that its overall height represents the same magnitude of voltage as the very first diagram (Fig. 3d). Finally, it is a matter of comparing the relative sizes of the areas within and between the first and last drawings. When bulb-B burns out, not only does the brightness of bulb-A increase and bulb-C decrease

Table 5
Solution steps in the Blown bulb problem using the AVOW diagram approach

Steps	Procedures	Diagrams
1. Draw AVOW diagram for good circuit (Fig. 3a)	AD1	B, C
2. Re-draw R_B as an insulator (Fig. 3b)	AD1	I, D
3. Re-scale R_A in relation to R_C (Fig. 3c)	AD2	H
4. Re-scale whole diagram (Fig. 3d)	AD3	F
5. Compare areas of R_A, R_C	AI4	
Procedures per step, knowledge steps	1	4

(changes in areas), but there is an effect on the currents (widths) through the other bulbs and the distribution of the voltages (heights) between them.

The solution using AVOW diagrams is easier both in terms of the number of steps and with regard to the relative complexity of the steps. This problem was used in the pre- and post-tests in the experiment. As will be seen below, the participants learning with AVOW diagrams found this problem simple to solve, some producing shorter solutions than Fig. 3.

2.3.2. Cube of bulbs

The Cube of bulbs in Fig. 4 is a complex three-dimensional circuit. What is its overall resistance (Problem 10, Table 3)? If the bulbs have unit resistance, the answer is $5/6 \Omega$. Table 6 shows the steps in an ideal algebraic solution. To be able to find suitable equations to apply it is first necessary to identify appropriate sub-networks, thus the first procedure is to re-draw the circuit in the more familiar form (Fig. 5a). This is not a trivial task because the new diagram has crossing wires that are not often encountered in the basic level in electricity (Step 1; Table 6). It is clear from this new flat layout that the network cannot be simply decomposed into sets of purely series and parallel load configurations, Step 2, so some special method is needed. An advanced approach using Kirchoff's laws and simultaneous equations could be used, but as there are 12 resistors this is impractical. However, given that the bulbs are identical one might

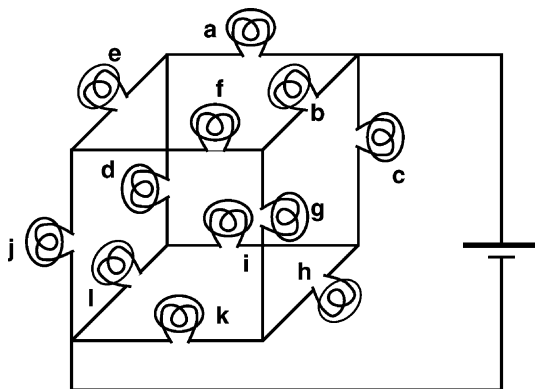


Fig. 4. What is the overall resistance of this cube of identical bulbs?

Table 6
Steps in the conventional solution to the Cube of bulbs problem

Steps	Procedures	Equations
1. Re-draw the circuit in 2D (Fig. 5a)	C3	
2. This is not a simply decomposable circuit	C1	
3. Re-conceptualise circuit in equivalent form (Fig. 5b)	C3	
4. $r_{ed} = \frac{r_d r_e}{r_e + r_d} = \frac{1}{2}$	EW1, EI1	(7)
5. $r_{sub} = r_a + r_{ed} + r_l = 1 + \frac{1}{2} + 1 = \frac{5}{2}$	EW1, EW2, EI1	(3)
6. $\frac{1}{r_{tot}} = \frac{1}{r_{sub}} + \frac{1}{r_{sub}} + \frac{1}{r_{sub}} = \frac{3}{r_{sub}} = \frac{6}{5}, r_{tot} = \frac{5}{6}$	EW1, EW2, EI1	(7)
Procedures per step, knowledge steps	1.8	3

re-conceptualise the circuit as shown in Fig. 5b, without altering the magnitudes of currents or voltages anywhere in the circuit (Step 3). This new circuit is then solved in the usual manner (Steps 4–7). The insight is an especially hard inference as it requires a deep understanding of the conditions in which different electrical circuits may be treated as equivalent.

In contrast, the solution to the Cube of bulbs problem with AVOW diagrams requires no special techniques or knowledge, as shown by the construction sequence in Fig. 6 and Table 7. Most steps involve use of the patterns for series and parallel arrangements of boxes applied to simple networks. The solution does involve a trick, as the box for bulb-l must be split between the two halves of the diagram (such three-dimensional circuits can be modelled by cylinders).

Comparing the totals in Tables 6 and 7 show there is just a small difference between the two approaches in the total number of procedures, but the AVOW diagram approach is more straightforward and less demanding. The transformation of Fig. 5a into Fig. 5b not only requires substantial insight but there are few cues to suggest that this is an appropriate step. The splitting of box-l in Fig. 6d is novel but the structure of Fig. 6c does provide a strong clue that this is the right inference. This problem is one of the transfer problems used in the delayed post-test of

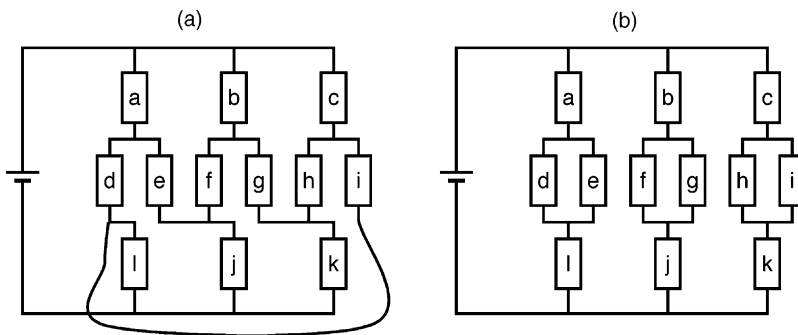


Fig. 5. The cube of resistors: (a) re-drawn and (b) re-conceptualised.

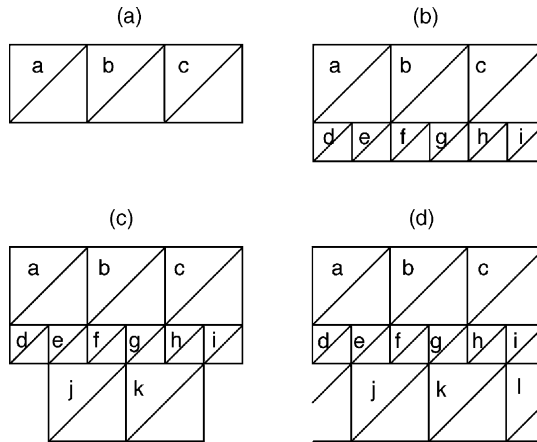


Fig. 6. AVOW diagram solution to the cube of resistors problem.

the experiment. As will be seen below, some of the participants using AVOW diagrams were able to produce solutions in this manner, but those using the conventional approach were not even able to begin.

Solutions were produced and analyses performed for each of the other eight problems in Table 3 (for details, see Cheng, 2000).

2.3.3. Overall comparison

For each of the 10 problems the number of steps and the average number of procedures per step are given in Table 8. The number of steps in the Equations approach is approximately double that of the AVOW diagrams, despite the use of short cuts and the greater aggregation of procedures in the steps of the Equations approach. The steps under the Equations approach contained over one and a half times as many procedures than the steps under the AVOW diagrams approach.

Table 9 summarises the approaches and presents various measures of their application in the 10 problems. For the AVOW diagrams, the declarative knowledge of the domains is

Table 7
Steps in the AVOW solution to the Cube of bulbs problem

Steps	Procedures	Diagrams
1. Draw AVOW boxes a, b, and c in parallel (Fig. 6a)	AD1	C
2. Add boxes d and e to box a (Fig. 6b)	AD1	B
3. Repeat for boxes f and g, and h and i, under boxes b and c (Fig. 6b)	AD1, AD1	B, C
4. Draw box j under boxes e and f (Fig. 6c)	AD1	B
5. Repeat for box k under boxes g and h (Fig. 6c)	AD1	B, C
6. Draw box l split between boxes d and i (Fig. 6d)	AD1, AD2	H
7. Infer resistance from overall height and width	AI3, AI1	A
Procedures per step, knowledge steps	1.4	7

Table 8
Steps and procedures in the solutions to the 10 problems

Problem	Equation		AVOW	
	Steps	Mean procedures per step	Steps	Mean procedures per step
1. Single load	6	1.8	4	1.0
2. Series network	8	2.1	6	1.0
3. Parallel network	8	2.1	6	1.0
4. Composite	8	2.3	8	1.3
5. Blown bulb	14	2.4	5	1.0
6. Resistance matching	10	1.3	8	1.6
7. Ideal and real batteries	22	2.5	7	1.1
8. Short circuit	7	2.3	5	1.6
9. Wheatstone bridge	22	1.5	6	1.3
10. Cube of bulbs	6	2.3	7	1.4
Total	111	2.1	62	1.3

Table 9
Comparisons of the two approaches over all 10 problems

Measure	Equations	AVOW
1. Declarative knowledge items		
1.1. Number of items (equation or diagrams)	27	10
1.2. Proportion of items used at least once	70.45%	100%
1.3. Average number of problems using each item	3.1	6.6
1.4. Lack of uniformity of use of items ^a	0.60	0.44
2. Steps and procedures		
2.1. Number of representation specific procedures	12	7
2.2. Mean number of steps per problem	11.1	6.2
2.3. Median number of steps per problem	8	6
2.4. Total number of procedures used	228	78
2.5. Mean number of procedures per step	2.1	1.3
2.6. Lack of uniformity of use of procedures ^a	0.51	0.34
2.7. Number of times general procedures (C1–5) used	10	3
3. Steps and knowledge items		
3.1. Proportion of steps associated with items	59.5%	75.8%

^a This is a linear measure, S , ranging from 0, for a complete uniformity, to 1 for a maximally skewed distribution.

$$S = \frac{\sum_{i=1}^N |x_i - x|}{2(N-1)x}$$

where x_i is the number of times each item (or procedure) i is used, x is the mean number of items, and N is the number of types of items. The numerator term indicates how much the use of each item differs from the average. The denominator is the maximum difference, which occurs when just one item is used all the time.

encoded in a smaller number of expressions (Table 9, item 1.1) and the representation specific procedural knowledge is also more compact than for the Equations approach (2.1). For the 10 typical problems considered, under the AVOW diagram approach all the diagrams were used fairly extensively and uniformly (1.2, 1.3 and 1.4), compared to the Equations approach. On various measures the AVOW diagram solutions were simpler, specifically: fewer steps (2.2, 2.3); smaller numbers of procedures, overall and per solution step (2.4, 2.5); greater uniformity of application of the representation specific procedures (2.6); less use of the general non-representation specific procedures (2.7); and, more knowledge steps, or fewer steps that are purely for the manipulation of expressions that did not directly involve the application of domain knowledge or problem information (3.1).

Although there are a number of limitations to this comparison of the two representational systems, as discussed in Cheng (2000), they do not impact on the finding that the AVOW diagrams approach is the more straightforward for solving these types of problem at this level of knowledge. The question is now whether, and how, these differences between the two representations impact on the learning of electricity.

3. Learning experiment

The aim of the experiment was to compare the effects on learning electricity with the AVOW diagrams representation and the conventional Equations approach. Strictly speaking, the comparison is not between these two representational systems, *per se*, but between each one used in conjunction with ordinary circuit diagrams. However, as the circuit diagrams seen by the users of the AVOW diagrams and the users of the equations were identical, issues concerning the comparison of two sets of multiple representations can be set aside.

The content and form of instruction, measures of learning outcome, the participants, the materials and the procedure are considered in turn.

3.1. Mini-curriculum

Two mini-curriculum for teaching basic electricity, using the different representational systems, were devised that cover the same content and possess the same overall structure. Each curriculum was based on one representation and avoids reference to the other. The topics covered were common to courses on basic electricity (e.g., Duncan, 1973; Hewitt, 1992) which typically include: (A) the basic properties of electricity; (B) Ohm's law and the Power law; (C) insulators and conductors; (D) series and parallel networks with consideration of how current and voltage are shared or distributed amongst loads under the different configurations, and the calculation of overall resistance; (E) analysis of networks by decomposition into isolable sub-networks and the recursive application of formulas or drawing routines; (F) switches modelled as insulators and conductors; (G) "shorts" and "cuts" as common faults in circuits, which are modelled by introducing conductors and insulators where the fault occurs; (H) batteries and mains supply as power sources; and (I) real batteries with an internal resistance, in contrast to ideal batteries.

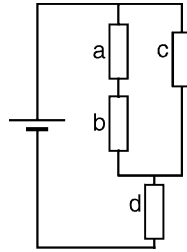


Fig. 7. A simple circuit.

The mini-curriculums covered all nine topics in roughly the listed order (A–I). [Appendix A](#) shows one page from the mini-curriculum for each approach dealing with parallel networks (D), which occurs about half way through the curriculum.

3.2. *Instruction*

A straightforward approach to instruction with the mini-curriculums was adopted. For each topic in turn, the participants were given information on printed sheets, such as [Appendix A](#) (Sections A.1 and A.2). This was followed by exercises on the topic, including some of the problems in [Table 3](#). For example, there were two exercises for the complex network topic (E). The first was to write an equation or to draw an AVOW diagram for the circuit in [Fig. 7](#). The second went in the reverse direction, requiring a circuit diagram to be constructed from an equation or an AVOW diagram. Written solutions with explanations were provided for each exercise. The experimenter also gave limited answers to any additional queries. These cycles of information giving, exercises and feedback were repeated for all the topics.

3.3. *Learning measures*

Various tests were used to assess the participants' knowledge of electricity and their understanding of how to use the representations for solving problems.

3.3.1. *Recall test*

In this test the participants were simply asked to recall everything they could about electricity. Whenever a participant paused the experimenter gave a generic prompt (e.g., “yes?”). If the participant appeared to be stuck the experimenter prompted with a general question that depended on what had been remembered so far (e.g., “Do you remember any equations?” or “What about different circuits?”). The extent and completeness of the information recalled is a measure of the quality of understanding and, additionally, the number of generic and question prompts gives some indication of the participants' confidence in their knowledge.

3.3.2. *Multiple-choice (MC) questions*

These questions were adapted from exercises and problems at the end of the chapter on basic electricity in [Hewitt's \(1992\)](#) physics text. The questions are typical of those used to assess the

understanding of electricity (e.g., Cohen, Eylon, & Ganiel, 1983; McDermott & Shaffer, 1992). There were 24 questions in total, which can be categorised into four groups according to the type of knowledge being probed and the complexity of the situation in question. These groups were:

- (B) *Basic questions* dealing with rudimentary facts about simple series and parallel circuits (five questions).
- (R) *Relation questions* requiring the application of basic laws of electricity (seven questions).
- (BI) *Basic interaction questions* requiring the comparison of properties in a given circuit with constant behaviour (five questions).
- (CI) *Complex interaction questions* that involve comparisons among properties in a circuit that has changing behaviour, because the circuit configuration alters or because the circuit malfunctions (seven questions).

An example of each of the four types of MC question are given in [Appendix B](#). The relative difficulty of typical problems in each class is, in increasing order: basic questions, relational questions, basic interaction questions and complex interaction questions. The Blown bulb problem ([Fig. 2](#)) was used as MC question 24 and is a good example of a complex interaction question.

Participants were allowed to use pen and paper to determine their choice of one answer from the five options given. Their “work scratchings” were saved. After selecting an answer, participants were asked to briefly explain their choice. These explanations were audio taped and transcribed. Both sources of data provided evidence about how participants obtain solutions to the questions.

3.3.3. Transfer problems

There were two problems that the participants attempted for the first time at the end of the experiment. These transfer problems provided additional information on the quality of participants’ understanding and their ability to use the representations for novel problem solving.

3.3.3.1. String of Lights problem. For this problem, participants had to answer three questions about the real world difficulties of designing decorative strings of lights. The problem stated that “A set of Christmas tree lights is connected to the mains supply of 240 V. Each bulb is 12 W and draws 1 A”. The questions were: (a) What happens if one bulb blows? (b) Design a new set of Christmas tree lights that doesn’t have this problem. (c) What’s the problem with the design in (b)?

It was anticipated that the participants would realise that such strings of lights are wired in series and, hence, when one blows they all go out, making it hard to find the bulb that is faulty. By wiring bulbs in parallel only the Blown bulb will be out making it easier to find.

3.3.3.2. Cube of bulbs problem. This was the problem considered above ([Fig. 4](#)) with the additional information that the bulbs have a resistance of 1Ω . If any of the participants using the Equations approach attempted the sophisticated strategy of re-drawing and re-conceptualising the circuit to find a simpler equivalent form, then [Table 6](#) would have provided a basis for assessing the quality of their solution method. As none did so, consider a textbook solution

under the conventional approach, which might include the following six stages: (1) show directions of current on the diagram; (2) set up equations for voltages or currents through various paths or nodes in the circuit; (3) substitute values of resistance into the equations; (4) ensure the number of different equations equals the number of bulbs (as many equations as unknowns); (5) solve these simultaneous equations; and (6) compute the answer. The more stages that are completed by the participants the better the quality of their attempted solution. Based on [Table 7](#), the quality of solutions produced by participants using AVOW diagrams can be judged according to how many of the following features they were able to produce during the construction of their diagrams: (1) some kind of composite AVOW diagram; (2) all AVOW boxes with the same gradient; (3) 12 AVOW boxes; (4) 12 boxes all with the same gradient (i.e., $2 + 3$); (5) an arrangement of boxes resembling [Fig. 6d](#) (with or without split or wrapping of bulb-1); (6) a correct and complete diagram as in [Fig. 6d](#). The more features that are presented in a solution the better a participant appears to understand how to use AVOW diagrams for problem solving.

3.4. Participants

There were two groups: an AVOW diagrams group (AVOW) and an equations group (EQNS). Of the initial 24 participants, after natural attrition, there were of 9 participants in each group for which there was complete data. The mean age of these participants was 19.5 years with a range of 16–23. Two-thirds of the participants in each group had a grade A in GCSE mathematics and the rest at least a grade C, so participants in the EQNS group would have had sufficient mathematical knowledge and skills for the conventional approach to learning electricity. Some participants had a GCSE science qualification and one participant in the AVOW group and two in the EQNS group had an Advanced level physics qualification. (In the U.K. GCSEs are school examinations taken at age 16 and Advanced level examinations are taken at 18, typically.) None, however, were undergraduates studying the physical sciences or engineering, although there were some undergraduate social scientists. Thus, the participants can be considered as novices in this domain. (The participant identification numbers are not consecutive in what follows, because of pilot work and the attrition.)

3.5. Materials

The MC questions were given to participants in the form of a booklet. Participants indicated their choice by circling one of the five answers. They were provided with pen and paper to do any working out they wished. The recall test, MC questions, and MC question order were the same each time the test was taken. For the String of Lights transfer problem, the participants were given a printed sheet with the problem statement and questions. For the Cube problem, participants were given the same plus a picture of the circuit ([Fig. 4](#), but without the labels).

3.6. Procedure

The experiment consisted of three sessions (durations are given). During the first session the recall test (<5 min) and MC questions pre-test (15 min) were administered. This was followed

by a screening test, which all the participants passed, that involved drawing rectangles like AVOW boxes or doing computations with formulas similar to the laws of electricity. The first part of the instruction covered the mini-curriculum up to simple networks (50 min). The second session followed the next day and began with a brief review of the latter sections of the first part of the instructions (5 min). The second part of the instruction covered material up to circuit problems and internal resistance of batteries (50 min). The MC questions post-test immediately followed (15 min). Approximately 5 days later the recall test (≈ 5 min), delayed MC questions (15 min) and transfer problems were administered (10 min).

4. Results

4.1. Overall learning outcomes

4.1.1. Recall test

From the transcripts of the recall tests, participants' knowledge about electricity was assessed by two independent raters identifying items in the protocols using a list of key facts about electricity. There was between 97 and 100% agreement between the raters.

Table 10 shows, for the pre-test, the number of participants in each group recalling particular facts. Some participants knew what components are found in circuits, and could name particular properties and simple network arrangements. A few common problems were stated but the lack of prior knowledge about relations among properties or the constraints on the networks confirm that these were novice participants. Neither group is near ceiling as the maximum possible score for a group is 180 (9 participants \times 20 facts). The EQNS group appear to know a more than the AVOW group, in general, although none of the differences between the two groups on any single item are significant at the $p = .05$ level in Fisher exact tests.

Following the instruction there was a switch away from the recall of particular features and components to statements about relations among properties and constraints applicable to different circuit configurations, which are more sophisticated views about the domain. The types of facts recalled by the two groups are roughly comparable, although they naturally relate to the respective representations, as shown in Table 11. For the AVOW group the recalled facts correspond closely to the ideal knowledge given in Table 1. Of the 9 facts there were 8 that a majority of the participants recalled (at least 5 of the 9 participants). For the EQNS groups a subset of 11 out of the 18 equations in Table 1 were recalled. Of these, 7 facts were recalled by a majority of the EQNS participants. To quantify the performance of the groups, albeit approximately, assume that the chance that a majority of participants recalling a particular fact was 50%, as it nearly was in Table 10. Modelling the pattern of facts being above or below that threshold using the binomial distribution, the probability of the particular number of facts being recalled by each group being due to chance can be computed. On this basis, the probability of at least 8 out of 9 facts being recalled by a majority of AVOW participants was $p = .02$. The probability of at least 7 out of 11 facts having been recalled by a majority of EQNS participants was $p = .27$. Thus, it is reasonable to conclude that the EQNS group had a poorer grasp of the basic relations and constraints of the domain.

Table 10
Initial pre-test recall test

Electricity—categories and facts	Number of Ss	
	EQNS	AVOW
Things		
Batteries	2	4
Resistors/loads	5	5
Bulbs	3	4
Switches	2	3
Properties		
Voltage	6	3
Volts	6	3
Current	4	5
Amperes	6	4
Resistance	4	5
Ohms	6	2
Power	2	2
Watts	3	1
Conductors/low <i>R</i>	7	6
Insulators/high <i>R</i>	7	6
Networks		
Series	5	5
Parallel	6	5
Problems		
Battery problems	3	2
Blown bulbs	5	3
Open circuits	2	5
Short circuits	0	3
Total	84	76

4.1.2. MC questions

4.1.2.1. *Overall performance.* For the MC questions, the score for each participant is the number of correct answers. Fig. 8 shows the mean overall scores, out of 24, for the two groups at the different times in the experiment. In a mixed design 2×3 ANOVA, on group and time of test, there was a significant main effect of time ($F_{2,32} = 51.5$, $p < .0001$) but not of representational group ($F_{1,2} = 0.06$, n.s.), plus a significant interaction ($F_{16,32} = 6.037$, $p < .01$). The difference between pre-test and delayed post-test scores for each group individually are significant (t -tests: AVOW, $p < .001$; EQNS, $p < .001$) but the difference between the groups was not significant at pre-test or delayed post-test (t -tests). Thus, learning has occurred with both sets of instructions, with the interaction implying that the AVOW group did better.

4.1.2.2. *Performance on particular question types.* The individual scores on each of the types of questions show some interesting patterns (Fig. 9a–d). For simplicity, consider just the pre-test and delayed post-test scores, in 2×2 mixed ANOVAs for all four-question types. There are main

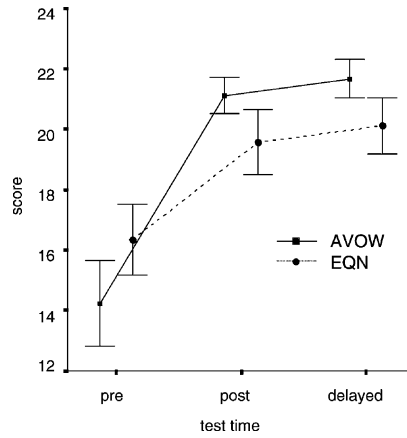


Fig. 8. Average of the MC questions overall scores for both groups.

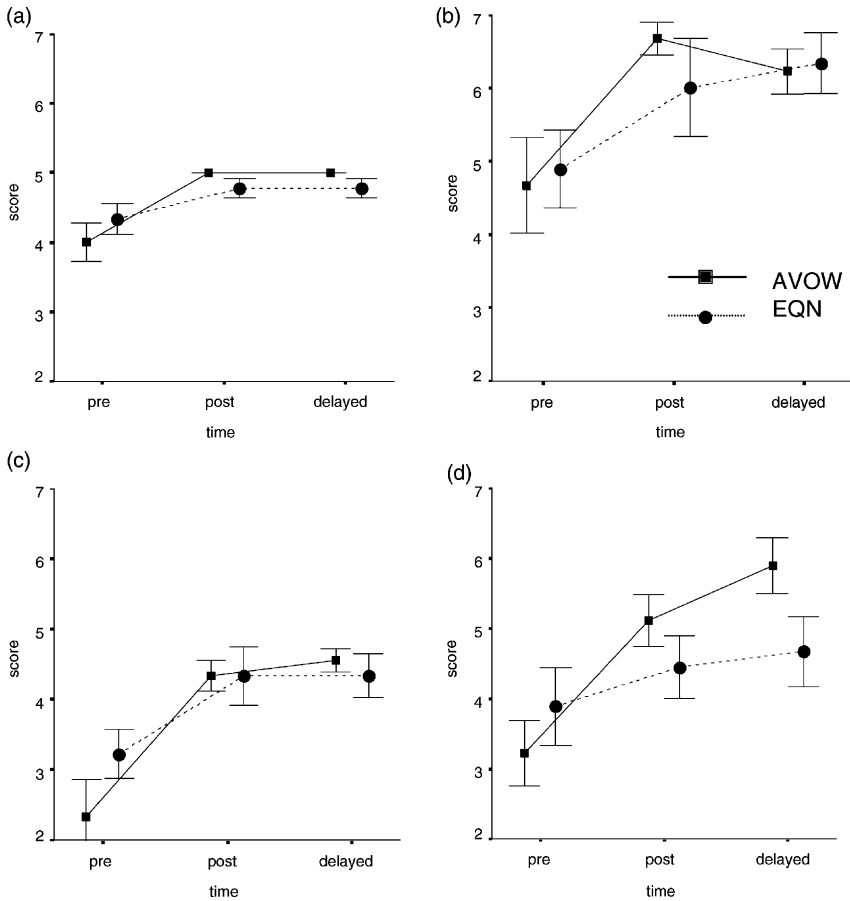


Fig. 9. Average of scores on the four types of questions: (a) basic, (b) relation, (c) basic interaction, (d) complex interaction.

Table 11
Proportions of participant in the two groups recalling various categories of electricity facts

Category	AVOW participants		EQNS participants	
	Facts	%	Facts	%
Basic relations	$V = \text{height}$	100	$V = I \times r$ (and variants)	78
	$I = \text{width}$	100	$P = I \times V$ (and variants)	78
	$r = \text{gradient}, r = \frac{V}{I}, V = I \times r$	100	$P = I^2 \times r, P = \frac{V^2}{r}$	22
	$P = \text{area and/or } P = I \times V$	100	$I_t = I_a = I_b$	33
Series relations	Stack AVOW boxes	89	$V_t = V_a + V_b$	44
			$r_t = r_a + r_b$	89
Parallel relations	AVOW boxes side-by-side	89	$V_t = V_a = V_b$	78
			$I_t = I_a + I_b$	33
			Either R_t formula	78
Network overall	Total resistance	22	–	
Component properties	Insulators are tall and thin	56	Switch open (huge resistance)	67
	Conductors are short and wide	56	Switch closed (low resistance)	67

effects of time of test (B, $F_{1,16} = 18.3, p < .0001$; R, $F_{1,16} = 10.1, p < .01$; BI, $F_{1,16} = 17.2, p < .001$; CI, $F_{1,16} = 33.4, p < .0001$) but not instructional group (B, $F_{1,1} = .06, n.s.$; R, $F_{1,1} = .09, n.s.$; BI, $F_{1,1} = .86, n.s.$; CI, $F_{1,1} = .18, n.s.$). There is a significant interaction for the complex interaction case (B, $F_{1,16} = 2.7, n.s.$; R, $F_{1,16} = .01, n.s.$; BI, $F_{1,16} = 1.9, n.s.$; CI, $F_{1,16} = 10.1, p < .01$).

Pairwise comparisons support the impression given by Fig. 9d, that the AVOW group have gained more than the EQNS group and out performed that group in the post-test, on the complex interaction problems. Specifically, the difference between the groups at delayed post-test is significant (t -test, $p < .05$); the pre-test to delayed post-test within group difference for the AVOW group is significant (t -test, $p < .001$); but the same is not true for the EQNS group.

The top of the scale on each graph corresponds to the maximum score, so for the basic questions the participants are at ceiling in the post-test and they are approaching ceiling for the relations and basic interaction questions. With respect to each type of question, both groups are learning during the course of the experiment. The groups are comparable on the basic, relations and basic interaction questions, but on the complex interaction problems the AVOW group's post-test performance was superior to the EQNS group.

4.1.2.3. Use of external representations. The extent of use of external representations when solving the MC questions was assessed by counting the number of times a participant wrote or drew anything whilst attempting the questions. Table 12 shows various measures of external representation use. In terms of the mean proportion of representation use per question the AVOW group were doing significantly more than the EQNS group. The external representations of the EQNS group were either formulas or numerical computations (Figs. 13 and 18 are examples). The external representations of the AVOW group were almost all exclusively

Table 12
External representation uses on delayed post-test MC questions

Question type	Proportion of questions		P (correct given representation used)		P (representation used given correct)	
	AVOW	EQNS	AVOW	EQNS	AVOW	EQNS
Basic	.73	.09**	1.00	1.00	.73	.09**
Relations	.83	.41*	.92	.88	.88	.40*
Basic interactions	.93	.22**	.90	1.00	.93	.26**
Complex interactions	.65	.03**	.85	1.00	.66	.05**
Total	.74	.19**	.92	.93	.78	.22**

Note. * $p < .01$, ** $p < .001$, two-tailed t -tests.

sketches of AVOW diagrams, with only occasional formulas or calculations (Figs. 10, 11 and 17 are examples). The use of external representations by each group was associated with correct answers as indicated by the respective high conditional probabilities of correct answers given representation use, over all of the problem types, as shown in Table 12. However, the low-based rate of representation use by the EQNS group means that the equations were unlikely to have been instrumental in this group’s correct answers, as confirmed by the low conditional probabilities of representation use given a correct answer. In contrast the AVOW group’s same conditional probability is significantly higher, which indicates they were using the diagrams to generate correct answers.

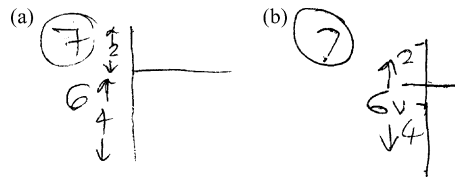


Fig. 10. Two incomplete AVOW diagrams: (a) S4; (b) S13.

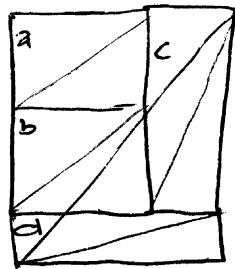


Fig. 11. Typical AVOW diagram solution to Exercise 6.1 (S4).

Table 14
Summary of stages of AVOW group attempted solutions to the Cube problem

Attempted stage	S2	S4	S6	S7	S10	S11	S13	S14	S15
Re-draw circuit diagram			1			1	1		
Composite AVOW diagram	1	1	1	1	1	1	1	1	1
All boxes same gradient	1	1	1	1	1	1	1	1	(1)
12 AVOW boxes	1		1		1				(1)
12 boxes same gradient	1		1		1				(1)
Nearly correct configuration	1		1		1				
Correct overall orientation					1				
Answer given	1.2	–	6/5	–	5/6	–	12	0.5	<1

scratchings, from both the immediate and delayed post-test and also from the exercises in relevant parts of the instruction.

4.2.1. Basic comprehension

4.2.1.1. *AVOW boxes and composite diagrams.* In the delayed recall test, summarised in Table 11, the AVOW participants knew how AVOW boxes represent the properties of the domain. Their recall of these facts always occurred in one short steady flow, which is suggestive of participants internally encoding the boxes as a single chunk or conceptual entity. For example, S6 is typical and stated within a few seconds (experimenters verbalisation in parentheses):

Okay, you've got volts along one side and current along the other with V and I , and then the gradient is R which is resistance and the area is P which is power ... (yeah) ... which are ... volts, amps, ohms and watts. (Yeah) ... If something's in series you pack them up this way and if it's in parallel you go across this way.

From the experimenter's observations and the video recordings, in the latter stages of the instruction and throughout the immediate and delayed post-tests, it is clear the participants were quickly and easily sketching individual AVOW boxes. Pauses in drawing typically occurred between complete AVOW boxes rather than during the construction of a single box. On examining the work scratchings, no cases of non-rectangular AVOW boxes were found (e.g., triangles). Occasionally participants did not complete the rectangle of AVOW boxes. For example, in all the working-out of the participants in the delayed post-test MC questions there were just five such diagrams; two are shown in Fig. 10. Although incomplete, they are not incorrect given the context of the questions being answered.

Similar observations were made for the recall and use of simple composites based on the stacking and side-by-side rules. The last sentence of the above quote from the delayed post-test recall is a clear example of this. The first time participants drew a complex composite was in Exercise 6.1 of the instruction, when they were given the circuit in Fig. 7. S4's drawing (Fig. 11) is representative. All but one AVOW subject (S10) drew such a diagram straight off in one attempt with no modifications. (S10's iterations seemed to be due to her attempts to give all the AVOW boxes equal gradients, although this was not required.) Later the AVOW group

were all quickly drawing composite diagrams for various circuit topologies, which indicates that it is easy to translate a circuit diagram into an appropriate configuration of boxes in a composite AVOW diagram. The Cube problem is an extreme case, because of the 12 loads and the three-dimensional nature of the circuit, but some subjects were nevertheless able to translate this unusual topology into an adequate composite AVOW diagram.

There were, in general, no cases of composites with gaps or composites containing overlapping boxes as final solutions, i.e., no violations of the constraints for assembling AVOW diagrams. MC questions 1, 6, 7, 10–13 involved networks that had components either purely in series or parallel. There were just three cases where a participant drew the wrong arrangement of boxes, a stack for a parallel network or a side-by-side line for a series network (S12 immediate post-test question 12; S13 immediate post-test question 1 and delayed post-test question 11). This represents a 2% error rate over those seven questions. By the delayed post-test, participants were drawing sets of AVOW boxes in a non-linear fashion; for instance all participants sketched a tall rectangle for the String of Lights and then subdividing it vertically into sections for each component. All this implies that AVOW participants have acquired perceptual chunks for basic configurations of AVOW boxes.

During the instruction on insulators and conductors, the participants had little trouble accepting the idea of AVOW boxes as line segments. Although recall of the nature of extreme cases of insulators and conductors in terms of their special form of AVOW boxes was not complete (Table 11), the protocols of the delayed MC questions and transfer problems show that most participants understood the relation between these extreme boxes and switches, and the problems of cuts and shorts in circuits. For instance, Fig. 12 shows S11's drawing for MC question 20 in which the break in part of the circuit caused by an unscrewed bulb is represented by a narrow AVOW box in place of a large square one. Further, the participants appear to have an alternative understanding of why a break in a circuit stops current flowing, in more sophisticated terms than it is merely broken. AVOW participant S15 on the String of Lights problem is a typical case in point: "If one bulb blows it's *resistance goes to infinity* . . . so basically they all . . . they all are going to go out" (emphasis added).

4.2.1.2. *Equations for relations.* On reading recall transcripts it is apparent that the AVOW group's recalled facts in quick succession, consistent with them being encoded and recalled

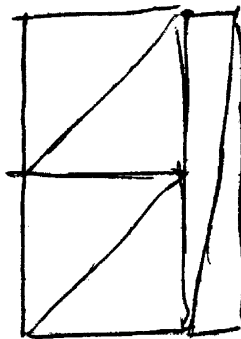


Fig. 12. Typical solution to MC Question 20 (S11).

2. $V = IR$ (with arrows pointing up from V and I, and a horizontal line above R)

3. $V = \frac{I}{R}$ (with arrows pointing up from V and R, and a horizontal line above I)

Fig. 13. Some of S32’s augmented equations.

as a unit of closely related chunks. In contrast EQNS participants’ verbalisation appeared more hesitant and disjointed. The coding and analysis of experimenter’s generic and question prompts following participants’ pauses and halts support this observation. The EQNS participants required significantly more of both types of prompts than the AVOW group: generic prompts, 15.3 versus 5.0, respectively (*t*-test, two-tailed, $p < .001$); question prompts, 10.0 versus 1.6, respectively (*t*-test, two-tailed, $p < .05$). The general implication is the AVOW participants obtained a firmer understanding of the basic facts and relations than the EQNS group.

The poor knowledge of the basic relations of the domain is evident in other aspects of the EQNS group’s performance. In the delayed post-test MC question there were three instances where incorrect equations were written: “ $I = R/V$ ” (S31, question 2), “ $P = I^2 \times V$ ” (S31, question 15), “ $R = V \times I$ ” (S27, question 16). This represents an error rate of 7% over all of this group’s questions for which an external representation was used. Other than for the Relations class of questions, there was a general reluctance to use the equations to answer the MC questions (Table 12) and similarly for the transfer problems.

The difficulty of reasoning about the relations among the properties using the equations is highlighted by S32’s need to augment formulas with additional symbols; for example, Fig. 13 shows how S32 drew arrows to indicate change and constraining lines for fixed magnitudes.

In Exercise 6.1 of the instructions, participants had to write a formula for the overall resistance of the network in Fig. 7. All but one EQNS participant (S29) incrementally built up the formula in a succession of expressions, which reflects the difficulty in translating a circuit topology into an equation. Fig. 14 shows a particularly clear example of this, by S32. The formula was rewritten four times to incorporate variables for additional loads. The mapping from the circuit topology to the formula is not straightforward (cf. Fig. 11).

The EQNS participants’ understanding appears to have changed little with regard to insulators and conductors, especially in relation to switches and circuit problems. In explaining why in the String of Lights problem all the bulbs go out, none of the participants treated the Blown

$$\begin{aligned}
 R_{A+B} &= R_A + R_B & R_{A+B} &= \frac{R_{A+B} \times R_c}{R_{A+B} + R_c} \\
 R_{\text{total}} &= R_{A+B} + R_D & R_T &= \frac{(R_A + R_B) \times R_c}{(R_A + R_B) + R_c} + R_D \\
 &= \frac{R_{A+B} \times R_c}{R_{A+B} + R_c} + R_D & &
 \end{aligned}$$

Fig. 14. Typical solution to Exercise 6.1 (S32).

bulb as anything other than a break in the circuit; for instance, S30 stated: “If one bulb blows they all would go out because *the circuit is broken*” (emphasis added). It is also noteworthy that during instruction several participants (S27, S29, S30, S33) had difficulty understanding why equations did not seem to make sense when resistance approaches zero (conductor) or infinity (insulator).

In summary, the EQNS group’s knowledge of the basic relations was fragmentary and incomplete. They had difficulty, or were at least reluctant, to use the equations for reasoning and problem solving. When written or verbal expressions of the formulas were not used, which was most of the time, explanations and solutions used verbal reasoning, presumably based upon whatever mental models the participants possessed, or guess work and intuition. In contrast, the AVOW group appeared to understand the relations well in the form of AVOW boxes and were able to reason effectively with them. They knew how to construct appropriate arrangements of boxes for given circuit topologies and understood rules governing legal composite forms. AVOW boxes and simple composites appear to be internally encoded as unitary conceptual entities, or perceptual chunks, which can be broken down into particular properties or boxes, respectively, as required.

4.2.2. Problem solving

Given the differences in the understanding of electricity attained by the two groups, it is not surprising to find that there are substantial differences between them in the approaches and procedures they used to solve problems. The AVOW group is considered first.

4.2.2.1. Constructing and comparing AVOW diagrams. In the construction and manipulation of composite AVOW diagrams, participants were managing to integrate the different levels of the domain, including: (L1) the values assigned to particular properties; (L2) the relations among, and constraints on, properties; (L3) the given circuit topology. For example, consider the two incomplete AVOW boxes mentioned above (Fig. 10). They were drawn for MC question 7, which concerned the voltages across two loads in series given the overall voltage. A plausible explanation for the missing parts of the AVOW boxes is that these participants realised that only the height of the stacked boxes (L1, values) is necessary to capture the distribution of voltage across series loads by the vertical dimension of the diagram (L3, layout), so the other parts of the boxes can, for convenience, be correctly omitted (L2, relations).

The solutions to MC question 24 and the Cube problem provide the clearest examples of how various levels of the domain can be successfully treated in an integrated fashion. Fig. 15 shows the best solution (S10) to the Cube problem. In the first attempt, top AVOW diagram, the right configuration of stacked and side-by-side boxes (L3, topology) is drawn, but S10 realised the gradients of the middle row of six are not correct (L1, values). The composite was re-drawn again with boxes of the correct proportions (lower diagram). S10 was then able to compute the total resistance from the overall height and width (L2, relation).

S2 and S6 produced similar composite diagrams, with appropriate arrangements and sizes of boxes, but they were confused about the overall orientation of the diagram. Fig. 16 shows the worst Cube problem solution, by S13, but even this has a configuration representing a series of three levels of parallel components all with equal resistances. S15 drew a large cube composed of smaller cubes, because she thought that a composite AVOW diagram for a three-dimensional

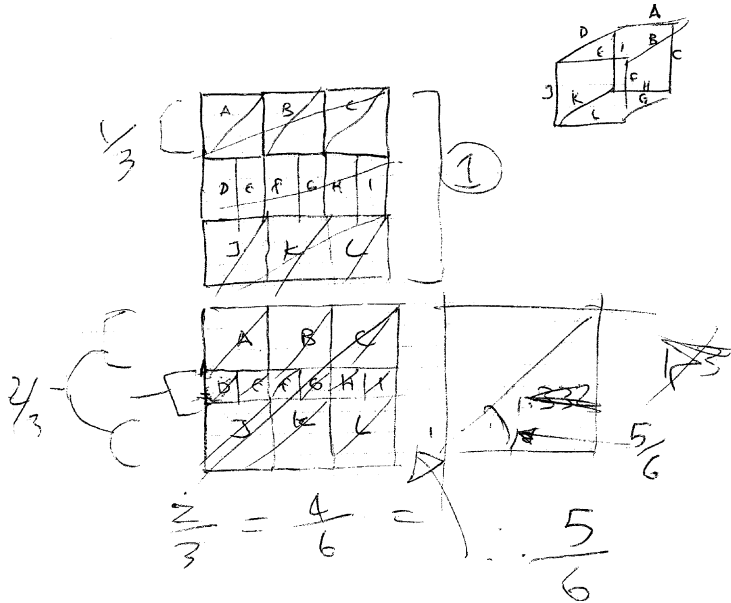


Fig. 15. The best AVOW diagram for Cube of bulbs problem (S10).

circuit might itself be three dimensional. Although S15's solution was invalid, it did manage to integrate magnitudes, relations and topology in a single diagram. The cubes were arranged in a $2 \times 2 \times 3$ configuration (L3), with clear indications in the working-out that the cubes had dimensions of unit length (L1) and the overall resistance is given by the gradient of a line between diagonally opposite corners (L2).

S10's solution to MC question 24 in the delayed post-test is typical, and it is a good example of the process of managing the constraints. Given the circuit in Fig. 2, S10 drew the far left AVOW diagram in Fig. 17 (left) to represent the initial correct operation of the circuit. With bulb A blown, it was represented by a line segment (insulator) to the left of B in Fig. 17

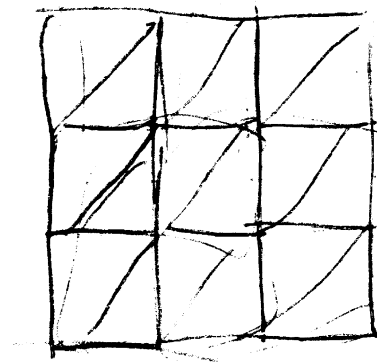


Fig. 16. The worst AVOW diagram solution for the Cube of bulbs problem (S13).

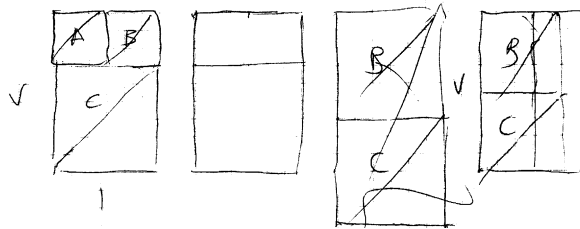


Fig. 17. Typical AVOW diagram solution to MC Question 24 (S10).

(middle-left), and B was given the same width as C. S10 did not bother to draw in the gradients because she spotted that they would not be equal, as required by the problem statement, so she simply moved on. The next diagram corrected this (Fig. 17, middle-right), but S10 then realised that the overall height did not match that of Fig. 17 (left), which it must, as the voltage source is constant. Thus, S10 drew Fig. 17 (right) with the correct overall height and initially with a width equal to the previous diagram. However, for the correct gradients the width had to be reduced slightly. Finally, comparing the first and last diagrams, the area/brightness of B has grown and the area/brightness of C has diminished. Including all the drawing this took 180 s. Notice the similarity between Fig. 17 and Fig. 3, the “ideal” solution from the task analysis above. Other participants produced even shorter solutions consisting of just two diagrams like first and last in Fig. 17.

4.2.2.2. *Limited use of equations.* The EQNS group found it hard to manage and integrate the different levels of information about the domain. During the instruction phase there were 18 cases where the participants transferred information from the written exercise onto the circuit diagram by annotating it (compared with two cases for the AVOW group). They appear to be attempting to make it easier to keep track of the given problem constraints. S32 was the only participant to use equations in the solution of MC question 24, in the delayed post-test, as shown in Fig. 18. Like Fig. 13, these equations were augmented with arrows and constraining lines. Although this was the best attempt, the reasoning in the long 406 word monologue that accompanied the solution was incorrect, because it only considered current changes locally and failed to deal with its change overall.

When the EQNS group were not using the equations formally, by writing algebraic expressions, they appeared either to be solving problems by reasoning verbally with the formulas or using their own informal mental models. These explanations were often erroneous for various reasons. In the MC question 24 in the delayed post-test, for example, S28 chose the right

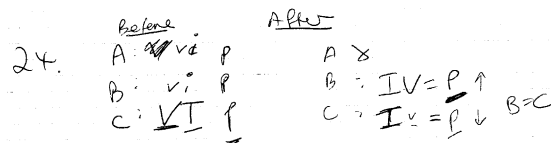


Fig. 18. S32’s expressions for MC Question 24.

$$\begin{aligned}
 V &= c + d + k. \\
 \cancel{V_c} \\
 V_c &= V_c + V_d + V_k. = (I \times R)_c + (I \times R)_d + (I \times R)_k \\
 V_c &= V_c + V_e + V_j \\
 V_c &= V_b + V_f + V_k \\
 V_c &= V_b + V_h + V_l \\
 V_c &= V_a + V_g + V_i \\
 V_c &= V_m + V_n + V_j
 \end{aligned}$$

Fig. 19. Best Equations approach attempt at the cube problem (S26).

answer but the explanation given was incomplete, because there was no consideration of how current is affected:

If bulb A is unscrewed then A will obviously go out but the potential difference across B will increase so . . . B'll shine brighter. But the potential different across C'll decrease because like previously the over[all] the resistance of C that was greater than the overall resistance of A and B but now they'll like even out. (mhm.) So, basically . . . yeah B will be bright and C will be dimmer.

S27's explanation also ignored the current but it implicitly assumed, incorrectly, that different parts of the circuit can be reasoned about locally in isolation from each other:

I think B'll be brighter and C will remain the same. (Okay.) Because with A it's sharing the voltage with A. (Yeah.) As long as A is not there B will get the . . . all the voltage. (okay.) Yeah. But C will just remain the same because that's the voltage it gets. (All right.) 'Cause I'm saying it will be a series circuit and . . .

Of the four participants who began writing equations for the Cube problem, just one, S26, appreciated that the reduction technique (replacing sub-networks with a single equivalent resistor) would fail and that an approach with simultaneous equations was required. Although this was the best attempt by any EQNS participant, Fig. 19 shows that it was quickly abandoned, presumably because S26 realised it was impractical. None of the participants attempted an approach like the solution in the task analysis that involved re-conceptualising the circuit (Fig. 5).

In summary, the AVOW subjects appeared to effectively manage the different levels of the domain and representation. They successfully integrated the different sources of information by drawing and re-drawing AVOW diagrams. In contrast, the EQNS subjects had a difficult time, sometimes using written equations but mostly resorting to informal verbal reasoning that was incomplete and that tended to avoid dealing with all the interacting constraints of the problems.

5. Representational systems for learning

5.1. AVOW diagrams support conceptual learning

Overall, the participants gained a better understanding of advanced high-school level electricity using AVOW diagrams than using the equations. The instruction given to the two groups

was equivalent in terms of the topics covered, the order of presentation, the general type of instruction and the amount of time. The only major difference was the representations. The difference in learning between the groups was apparent in the recall test, the MC questions and the transfer problems. The extensive use of the AVOW diagrams after instruction implies that the performance of the AVOW group is attributable, at least in part, to the diagrams rather than, say, due only to an enhanced verbal understanding of electricity.

The AVOW group outperformed the EQNS group on the questions and problems that were the most complex and challenging, specifically the complex-interaction MC questions and the Cube of bulbs transfer problem. Nevertheless, it might be argued that equations could better support the basic, relations and perhaps the basic interactions class of MC questions, because the ceiling effect on the problems was preventing the EQNS performing to the full (Fig. 9a and b). Given more difficult problems in these classes of problems the EQNS group might show greater learning gains. However, given the better recall test scores of the AVOW group and their superior performance on the complex-interaction and transfer problems, which incorporate aspects of the other three classes of questions, it seems unlikely that equations would outperform AVOW diagrams in such circumstances.

It is possible that the apparent benefits of AVOW diagrams could be due to their novelty creating a motivational effect on the AVOW group. However, this is unlikely to be more than a minor influence because the learning gains of the two groups were not uniform across the different classes of problems. There were gains for both groups in all classes but the AVOW group did better in the complex interaction problems and the Cube transfer problem, which suggests that other processes were involved.

The claim that AVOW diagrams can enhance conceptual learning is also supported by a study that followed the present experiment. It was conducted in real school classrooms and showed that AVOW diagrams effectively promoted the acquisition concepts and problem solving methods by students (Cheng & Shipstone, *in press*, b). Shipstone and Cheng (2001, 2002) consider how AVOW diagrams should be used in school level science teaching. The invention and potential of AVOW diagrams raises many questions in relation to other approaches to learning electricity, which Cheng and Shipstone (*in press*, a) discuss.

5.2. How representations can support learning

This sub-section considers why the two representations supported learning to different degrees. The explanations will in turn provide the basis for the identification of the six characteristics of effective representation systems considered in the following sub-section.

Three processes appear to be responsible for the differences in support for learning given by the two representational systems.

5.2.1. Acquisition of coherent networks of concepts

The patterns of problem solving and the content of the work scratchings produced by the AVOW participants suggest that they have acquired coherent conceptual networks whereas the equations seem to have left the learners with a fragmentary and incomplete conceptualisation of the domain. Fig. 20 illustrates the network of concepts that many AVOW participants appear to have acquired. Each AVOW diagram in Fig. 20 represents a perceptual chunk. Simple

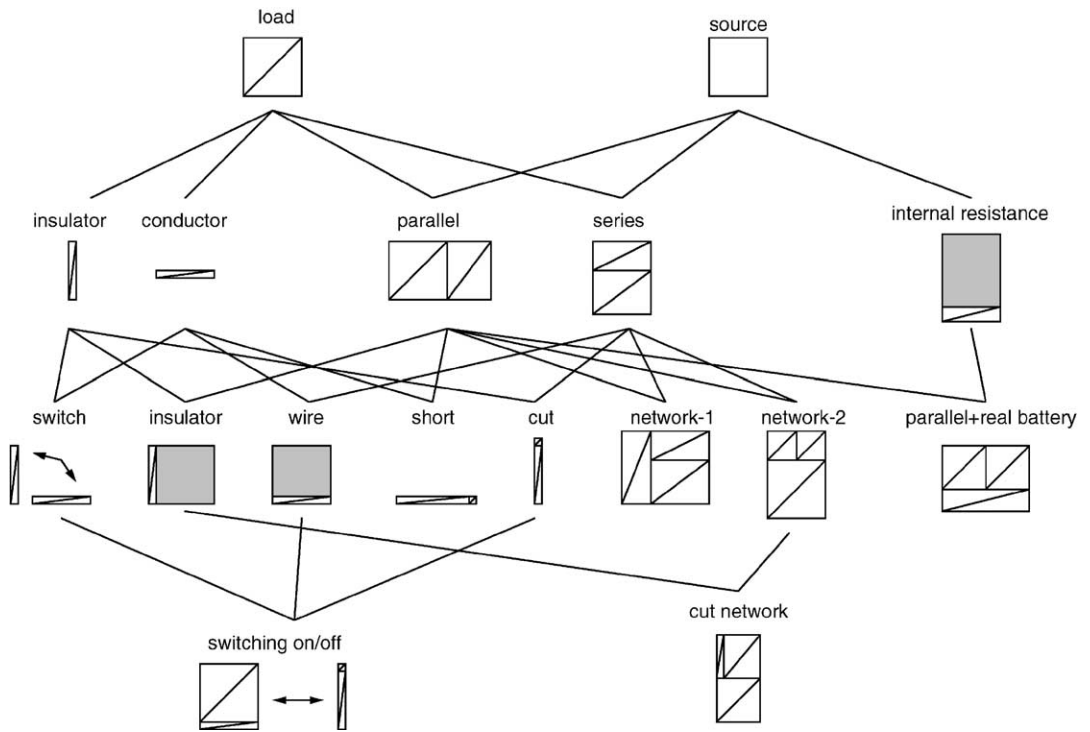


Fig. 20. Network of AVOW diagram concepts.

concepts acquired first appear towards the top of the hierarchy and are composed into gradually more complex concepts lower in the network. The links stand for operations that compose or transform diagrams. On the same level, certain pairs of concepts are placed adjacent to each other because they are closely related conceptually (e.g., insulators vs. conductors). The specific chunks present in Fig. 20 were ones typically recalled by the AVOW group in the post-tests and the links between them were included whenever there was usually a temporal contiguity amongst the associated diagrams. For example, the *parallel*, *series*, *insulator*, *network-2* and *cut network* chunks were simultaneously present in the solution to MC question 24 (Fig. 17).

The EQNS participants appear to have a less well-developed conceptual understanding, both in terms of the quantity of the facts and laws they have learnt but also with regard to how they appeared to be structured in memory. Many of the participants were unable to recall important basic relations in the delayed post-test and there is little evidence that these concepts are interrelated in any coherent fashion. For instance, the participants were often unable to identify which equations should be used in different problem contexts. It does not appear that the EQNS participants acquired the conceptual distinctions that the other group gained, such as the idea that insulators and conductors are fundamentally the same class of entity, being merely extreme cases of loads. Similarly, there was an absence of evidence for the group having closely associated sets of formulas for describing the electrical properties of networks with more than two loads. Thus, it was not possible to derive a network of concepts, equivalent to Fig. 20, for the EQNS group.

5.2.2. *Acquisition of problem solving procedures and strategies*

The AVOW participants benefited from being able to acquire and then use an effective set of problem solving procedures and strategies. Not only were they using the diagrams for post-test problem solving, but the range of methods and techniques they were using was relatively narrow. The common approach was to construct diagrams to model the given circuit, whilst satisfying both the general rules of AVOW diagrams and the stated constraints of the problem. This approach did not substantially change over different circuit configurations or for circuits that were more complex, although interactive drawing and re-drawing were sometimes necessary. Further, the solution paths were typically short and straightforward, with there being few cases of chains of inference or sequences of drawings leading to dead ends and so requiring the participant to re-start the problem from scratch. There were a number of cases where some backtracking was required because the initial solution found was recognised by the participant to be wrong in some way. However, in those cases the incorrect diagram usually provided some clue about how to modify the diagram to correct the error. The participants' solutions often resembled the ideal solutions considered in the task analysis.

The EQNS participants showed little evidence of having acquired an adequate set of problem solving procedures and strategies necessary for them to be able to successfully solve problems using the equations representation. There was relatively little use of the formulas during the post-test, either in the form of written expressions or as verbal statements of algebraic relations, which is why the group largely relied on informal verbal reasoning. There are a number of possible explanations for this state of affairs: the participants may simply not have learnt the procedures; they may not have known in what situations particular procedures could be applied; they may have chosen not to use the procedures for some reason, perhaps they felt the manipulation of equations was too difficult. It seems likely that all three possibilities occurred to some extent. In the recall of facts and relations about electricity, many of the important formulas were not mentioned. Of those that were recalled, it was often the case that they were not used during problem solving. There were also cases where equations were used, but after a few manipulations the approach was abandoned. The problems in which the equations were used successfully tended to be ones that could be solved in two or three steps, such as the Relations class of MC questions. In general, the EQNS participants were using a combination of informal verbal reasoning and whatever mental models of electricity they had managed to acquire.

5.2.3. *Signal to noise in learning*

There is an additional benefit that appears to accrue from a representation that supports the easy acquisition of a coherent network of concepts and relatively simple and straightforward problem solving procedures. Specifically, such representations may provide participants with a greater proportion of good learning experiences. This may occur not just during the instruction but also during immediate post training problem solving, particularly on more conceptually demanding questions, with a consequent impact on later problem solving.

The more coherent and completed conceptual network acquired by the AVOW participants appears to increase the likelihood of correct answers being derived, and hence being good cases for learning. Such a network may allow concepts relevant to a problem to be easily identified and to support the generation of novel configurations of AVOW diagrams as solutions. For

example, when the network of bulbs in Fig. 2 is seen by a learner for the first time, an AVOW diagram for the network can be drawn by simply combining the diagrams for the basic series and parallel network configurations, network-1 in Fig. 20. Later when the Blown bulb problem is encountered the combination of this new composite diagram with the diagram for modelling insulators within a network allows the solution to be quickly inferred, network-2 in Fig. 20. The small number of diagrams that have to be considered and their direct relevance to the solution probably increases the likelihood that a new concept, or chunk, will be learnt that combines the goal context and solution expression. The patterns of solutions of the AVOW participants are consistent with this interpretation.

In contrast, the EQN group probably lacked such a complete and coherent network of concepts that meant that when they attempted to use an algebraic solution they would usually have to revert to the formulas for the most basic configurations and perform an extended series of manipulations. This would have produced a substantial number of expressions, which tended to obscure the equations most relevant to the problem context, and hence could have reduced the likelihood that a concept relevant to the particular context would have been acquired.

With regard to the problem solving procedures, complex solution paths tended to reduce the number and portion of potential learning events in at least three ways. First, solutions may be more complex because they involve a greater number of inference steps. This reduces the number of cases that can be considered in a given time. Second, solutions may also be complex when there are many different operations that could be applied at each step in a solution. Again, this tends to limit the number of cases that can be examined, because problem solving strategies that are highly branching increase the time spent pursuing unfruitful solution paths. Third, errors are more likely when the solution path is complex, simply because there is greater opportunity to make mistakes. If the errors are spotted, the penalty is one of lost time. More seriously, if the error goes uncorrected, then the learner may acquire an erroneous concept, which will be a source of confusion and later a cause of concomitant errors.

The AVOW participants appear to have suffered less from these potential difficulties, because their problem solutions tended to be relatively straightforward and typically follow a common pattern. The EQNS participants fared worse in this respect. When the equations were used, which was less frequently than the AVOW diagrams, there were examples of incomplete and incorrect solutions. The proportion of signal to noise of potentially positive learning events was apparently greater for the AVOW participants than the EQNS group. In turn, this may be attributed both to the nature of the conceptual structures acquired by the different participants and also to the forms of problem solving procedures they learnt.

5.3. Characteristics of effective representational systems

The contrast between the two representational systems suggests possible characteristics that may distinguish good from poor representations for learning in complex domains. Two classes of characteristics (principles) are hypothesised. The *semantic transparency* set follows from the differential support that the representations give to the acquisition of coherent networks of concepts. The *plastic generativity* set comes from the consideration of the differences in the efficiency of problem solving strategies.

5.3.1. *Semantic transparency*

The three semantic transparency characteristics consider relations or mappings between (a) the “static” structure of expressions, or sets of expressions, in a representation, and (b) the principal invariants, major conceptual distinctions and important underlying regularities of the domain. There are many different ways conceptual structure of a knowledge rich domain may be encoded in a representational system. It is hypothesised that a representational system that makes the nature of the domain directly apparent in the inherent structure of the representation itself will be likely to enhance learning by making interpretations of laws and cases easier, which in turn will contribute to the development of coherent networks of concepts and raise the signal to noise ratio of positive learning episodes. A representation that encodes the domain using notational formats that are in themselves largely arbitrary with respect to the nature of the domain will be a poor representation. The three identified semantic transparency characteristics are proposals of how different conceptual dimensions should be encoded within the inherent structure of a representation.

5.3.1.1. Integrating levels of abstraction. It is proposed that a good representation should effectively integrate the different levels of abstraction of a domain. Representational devices should be used to support a close conceptual connection between the possible cases, or instances of phenomena, and the laws or underlying invariants of a domain.

AVOW diagrams combine different levels of abstraction that are important in electricity by using the same diagrammatic expressions to simultaneously encode the laws of electricity and the particular magnitudes of the electrical properties, using geometrical rules and the shape and size of diagrammatic elements, respectively. Having information at the different levels of abstraction readily available may help learning in two ways: (1) when considering particular cases it can provide a sense of the typicality or extremeness of the cases (e.g., Fig. A vs. Figs. D and E, [Table 1](#)); (2) when examining the general laws it can give a concrete context within which to interpret the laws (e.g., the values in Fig. A help the comprehension of the constraints on basic AVOW boxes).

The algebraic representation distances the levels of abstraction from each other by using separate formulas and procedures to encode the laws of the domain and to assign values to particular properties (e.g., [Eqs. \(1\)–\(10\)](#) vs. [Eqs. \(11\)–\(18\)](#) in [Table 1](#); procedure classes EW2 and EW3 vs. EI1 in the task analysis). This distribution of information makes it harder to understand how the laws and particular cases are interrelated, because a sense of the relation encoded by the law is easy to lose when multiple substitutions and manipulations are needed to combine the two streams of information (e.g., [Table 4](#)). In other words, specific cases cannot usually be interpreted meaningfully by the mere substitution of known values directly into the general laws of the domain.

5.3.1.2. Combining globally homogeneous with locally heterogeneous representation of concepts. It is posited that an effective representation should, on the one hand, support a unified overall conceptualisation of the domain—a globally homogeneous representation of concepts. Such a representation will have an overarching representational scheme that encodes the deep regularities of the domain, which will constrain the form of possible expressions such that they all directly reflect the inherent structure of the domain. On the other hand, the representation

should also simultaneously distinguish conceptual differences where they naturally exist, over and above any universal invariants of the domain—a locally heterogeneous representation of concepts. Such a representation will have particular lower level representational features that make the alternative concepts apparent.

At a global level, two of the fundamental invariants of electricity are the conservation of current within a circuit and the manner in which potential difference is distributed around a circuit, namely Kirchhoff's laws (Table 2, Eqs. (23) and (24)). AVOW diagrams have a uniform and pervasive coherent scheme for encoding both laws in terms of the constant sum of the widths of boxes and the constant sum of the heights of boxes. This is captured by the rule that a complete and correct AVOW diagram is a rectangle containing no gaps and no overlapping boxes. Even though Kirchhoff's laws were not explicitly introduced during instruction, the AVOW participants were in effect applying them implicitly in their use of the diagrams. AVOW diagrams have an overarching interpretive scheme that applies consistently across all expressions for all circuit types and problem cases.

The same is not true for the Equations approach. The fundamental concepts of current and voltage conservation are: (1) distributed across the sets of equations applicable to different circuit configurations (e.g., Table 1, Eqs. (3)–(6) vs. Eqs. (7a)–(10)) and (2) distributed among the separate equations pertaining to each individual property, for each of those circuit configurations (e.g., Eqs. (3)–(6)). For students using this approach there is no directly available overarching scheme to guide their interpretations or to assist them in spotting the underlying patterns in the domain. (Stating Kirchhoff's laws explicitly in algebraic form would be unlikely to help as they can only be used indirectly to interpret the local and global behaviours of a circuit.)

At a local level, there are many important specific distinctions to be made; for example, series versus parallel networks, insulators versus conductors, and alternative arrangements of three loads. AVOW diagrams support learning by making such conceptual contrasts clearly apparent. There are quite distinct arrangements of AVOW boxes for series and parallel networks; there are different shapes of single boxes for insulators and conductors; different diagrammatic dimensions (e.g., height, area) are used to represent physical dimensions or units of properties (i.e., Volts, Watts); size of particular elements represent magnitudes of different properties (e.g., 1 vertical cm = 10 V, 2.4 mm² = 0.24 W). The equations representation does not make such distinctions clear in the structure of its expressions for various reasons: several equations have the same abstract mathematical structure (e.g., Eqs. (3), (4), (6), (9) and (10) in Table 1 have the form " $A = B + C$ "); alphanumeric characters are used for properties (e.g., V , W), particular quantities (e.g., V_1) and magnitudes (e.g., 1).

5.3.1.3. Integrating perspectives. It is hypothesised that a good representation should integrate the alternative perspectives that may be taken of a domain. A representation may support such integration by encoding alternative perspectives within the same configuration of symbols, so that a different view can be taken by simply shifting one's attention between different features or combinations of features that pertain to alternative perspectives at the same level, or even between levels. Being able to switch between perspectives may help problem solving by making alternative operators or strategies available when impasses are met. Learning may similarly be promoted by the access to alternative views that can provide mutual constraints on possible interpretations, which constitutes a form of conceptual triangulation.

It is possible to interpret electricity from a number of different perspectives and at various levels, including: (1) formal relations among properties versus models in terms of current flow and voltage as a force (hydraulic model); (2) treatment of circuit topology at various levels of decomposition, taking sub-networks as unitary wholes or as component parts; (3) alternative relations among the properties (e.g., Ohm's law and the Power law).

The equations representation does not integrate any of these perspectives.

- (1) A natural and comprehensive interpretation of the equations, in isolation, using the hydraulic model is difficult, in part because the circuit topology is not represented explicitly.
- (2) It is hard to judge which parts of the formulas for a complex circuit apply to different sub-networks without references to a circuit diagram.
- (3) Multiple equations are needed to encode the alternative forms of relations of the domain (e.g., $V = I \times r$, $P = I^2 \times r$).

The AVOW diagram representation integrates all these perspectives.

- (1) They can be interpreted not only in terms of formal relations but also as causal models of current flow. Cheng (2001) describes how AVOW diagrams can be viewed as a system of pipes and horizontal sections taken as isobars or equipotentials.
- (2) Groups of AVOW boxes can be treated either as whole isolable units or as individual boxes within a composite. Further, the topology of networks is explicitly represented in the spatial layout of boxes.
- (3) Alternative relations can be read from the diagrams by focussing on different combinations of diagrammatic features of a single diagram (e.g., height–width–gradient, area–width–gradient).

5.3.2. *Plastic generativity*

The three plastic generativity (or syntactic plasticity) characteristics consider the use and usability of the representations for solving problems. They are concerned with the “dynamic” transformation of expressions and the practical consequences of the application of the syntactic rules during the problem solving process. Viewing problem solving as heuristics search through a problem state space (Newell & Simon, 1972), an effective representation should allow the expression for a target concept to be directly generated from the expressions standing for the given concepts. A representation with simple means to generate and transform expressions is likely to enhance learning by providing problem solving procedures and strategies that are can be easily mastered. It may also raise the signal to noise ratio of positive learning episodes as derivations will be more efficient and less error prone. The three identified characteristics are concerned with how a representation may make the search of a problem state space simple in three different senses.

The term “plastic generativity” comes from an analogy between the use of plastics (polymers) for physical modelling and the generation of expressions in representational systems for conceptual modelling (Cheng, 1999c). The properties that make plastics attractive for producing material forms are paralleled by the characteristics that representational systems seem to require for effective generation of meaningful expressions.

5.3.2.1. Malleable meaningful expressions. It is proposed that a good representation should be *malleable* (like plastic), that is it should have expressions that are neither too rigid nor too fluid. In a rigid representation it is hard to transform a given expression into some target expression, because it is difficult to find or apply procedures that generate the necessary intermediate expressions. In a fluid representation it is possible to generate a great many valid expressions from any given expression. Rigid and fluid representations will impede learning because they will hinder the finding of relevant meaningful expressions, either by blocking the search or swamping the user with a great many arbitrary but largely irrelevant expressions. By avoiding these two extremes a malleable representation is likely to effectively support learning.

The ways in which AVOW diagrams can be manipulated are relatively well constrained, but not so over constrained that there are conceivable cases that cannot be modelled. The procedures to generate meaningful expressions are neither too flexible nor are they too rigid. They do not allow relatively meaningless and arbitrary expressions to be formed, nor do they prevent expressions from being generated for meaningful problem states. Examples of correct solutions to all of the post-test and transfer problems were produced by the AVOW group. The participants rarely generated diagrams that were largely meaningless with respect to the domain or that did not make progress towards a solution. The task analysis presented above shows that there are usually only a few procedures that are relevant to a given problem context.

In contrast, the Equations approach is, in general, a highly flexible system, as there are normally many possible manipulations that could plausibly be applied at each step in the solution to a problem. In typical problems there are usually multiple equations to be considered, each of which can be transformed by a wide variety of mathematical operations available in basic algebra. The solutions considered in the task analysis were direct paths to the goal expression, with no strategic errors in the selection of equations or operations. Less than ideal solution paths for the two representations vary even more dramatically in the numbers of solution steps when wrong directions are taken and errors made. Unlike the AVOW diagrams, the Equations approach does not provide immediate clues that mistakes have been made, or that inappropriate methods have been used, until a dead end is reached. In some cases the Equations approach is rigid, because it is occasionally far from obvious what procedures are appropriate to use on certain types of problem. This may have been the case with the MC complex interaction questions and the transfer problems.

5.3.2.2. Compact sequences of procedures and uniform procedures. Consider the last two characteristics together. It is posited that a representation will better support learning when it requires: (1) short or compact sequences of procedures for the solution to problems and (2) fewer classes of procedures for problem solving. In other words an effective representation should have problem state spaces that are relatively shallow and that have a low branching factor. Note that a representation that has uniform procedures may nevertheless be a fluid representation, because each of its procedures might be applicable to a given expression in many different ways.

When using a representation that involves long sequences or has many different procedures this will negatively impact on learning. Learning demands are greater in both cases, because long and tortuous sequences of operators will be hard to remember and greater numbers of procedures take longer to master. Such representations will also be detrimental to learning

because the sequencing or selection of greater numbers of operations and procedures will require more time to process and will make problem solving more error prone, which will reduce the number of positive learning episodes seen for the same overall effort.

The task analysis, and to a lesser extent comparing the participants' solutions across the two groups, shows that the AVOW diagram solutions to the representative range of problems require a smaller number of steps and fewer procedures per step. Similarly, the variety of procedures used under the AVOW diagram approach is less than the Equations approach.

5.3.3. *Related work and application of the principles*

It is claimed that representational systems will be more effective for conceptual learning if they integrate levels of abstraction, combine globally homogeneous with locally heterogeneous representation of concepts, integrate perspectives, are malleable, have compact sequences of procedures and possess a uniform set of procedures. These principles differ in two main ways from previous principles and analyses of representations (e.g., Bertin, 1983; Carpenter & Shah, 1998; Cleveland & McGill, 1985; Kosslyn, 1989; Pinker, 1990). First, they are primarily concerned with problem solving and learning in particular, rather than the presentation of data mainly for the communication and interpretation of information (e.g., quantitative data charts). They address representations as generative systems that are used for modelling by the manipulation of expressions. Second, they are intended to be applied to complex conceptual domains, which cannot be satisfactorily reduced to a small number of dimensions of information (cf. Zhang, 1997). Analysis of representations using these principles must be considered in the context of the nature of the domain, which in turn demands an explicit characterisation of the conceptual structure of the domain as distinct from its informational structure. The principles address how the representational systems encode the laws, underlying patterns, typical and extreme cases of the domain and the manipulation procedures of the representations for generating meaningful expressions. The nature of the relations between the deep structure of the domain and the underlying structure of the representational system are thus critical in this account.

For the given delimited knowledge domain and the specified problem classes considered here, AVOW diagrams are effective because they constitute a representational system that satisfies these principles. This is, in part, due to their diagrammatic form. In other words, like LEDs, in general (Cheng, 1996b, 1999a), AVOW diagrams have the advantages of diagrams as identified by Larkin and Simon (1987). Information in AVOW diagrams is indexed by location, perceptual operators can be used to make inferences, and little matching of alphanumeric symbols is necessary. Similarly, under Stenning and Oberlander's (1995) perspective, AVOW diagrams constitute a limited abstraction representational system, which is sufficiently expressive for the domain of electricity, but is not so under constrained that arbitrary expressions may proliferate.

The particular formulation of diagrammatic constraints in AVOW diagrams means that many of the important relations are intrinsic, in Palmer's (1978) sense, to the representation itself. They are mostly inherent in the structure of the representation so the user does not have to remember the constraints as logical relations and deliberately impose them from "outside". AVOW diagrams provide many good examples of the potential cognitive benefits of distributed representational systems as described by Zhang and Norman (1994). The differences between

the two groups in the experiment well illustrates Zhang's (1997) claims for a limited form of representational determinism. The way participants think about the domain and their approaches to problem solving are substantially influenced by the representation they are learning.

Like LEDs, in general (Cheng, 1999a, 1999d), the internal mental representation of AVOW diagrams is in some ways similar to Koedinger and Anderson's (1990) *diagrammatic configuration schema* (DCS). DCSs are perceptual chunks with associated information about the facts and inferences that can be obtained from or made with particular geometric configurations. The analysis of the behaviour of the AVOW participants towards the end of the experiment suggests that they were beginning to use the diagrams in a manner similar to Koedinger and Anderson's expert geometry problem solvers and beginning to attain some of the commensurate benefits. LEDs differ from DCSs in that they encode information not only about the structure of the diagrams but also about the nature of the domain.

Since the completion of the above experiment with AVOW diagrams, further work has been conducted to evaluate the representational principles by using them to analyse existing representations and to design novel systems for complex conceptually demanding or information intensive domains (e.g., particle collisions, Cheng, 1999b; probability theory, Cheng, 1999c; Cheng & Pitt, in press; scheduling, Cheng, Barone, Cowling, & Ahmadi, 2002). Additional research is also required to address the relative importance of the principles; which ones should designers of representational systems attempt to satisfy when the requirements of all six principles cannot be met? Such investigations may be conducted by designing and evaluating novel representations that, unlike AVOW diagrams, satisfy some but not all of the principles. (Variants of AVOW diagrams have been designed to be poor LEDs.)

5.3.4. *Scope of the representations and scope of the principles*

The task analysis and experiment demonstrated interesting differences in the way that AVOW diagrams and the conventional Equations approach support conceptual learning, which in turn was the basis for the inferences about the six characteristics. However, the context in which the evaluations were conducted means that the claims about the relative merits of the two representational systems and the scope of the six principles should be qualified. Two aspects of the context are pertinent in this regard.

The first contextual aspect is the particular scope of the knowledge covered, which was direct current (DC) electricity at advanced high-school level with a specific focus on formal constraint-based interactions (i.e., Tables 1 and 2). This is just one of the many topics that constitutes the domain of electricity in general. Will the relative merits of the two approaches be the same with other electricity topics? More precisely, how will the representations fair with respect to each of the six principles of effective representations? Although these are open questions, it is worth briefly examining the capacity of the two representations to cover other topics.

- *Hydraulic analogy and electron motion.* AVOW diagrams support the comprehension of electricity in terms of the hydraulic analogy and in terms of electron motion at a microscopic level with only minimal extension to its basic format (Cheng, 2001). This is possible because both topics simply require different but complementary interpretive schemes to be applied to the basic diagrams. The inclusion of these topics into the knowledge domain covered by AVOW diagrams is unlikely to change the status of the representation

with respect to the six representational principles. The hydraulic analogy and microscopic perspective are not possible under the equations representation without extending the representation, for instance by augmenting the circuit diagram with arrows to show forces and flows. This will reduce the semantic transparency and plastic generative of the approach, because of the addition of complexity introduced by the supplementary representational formats.

- *Multiple voltage sources and time varying components (e.g., capacitors)*. AVOW diagrams can be extended to model these phenomena by using multiple diagrams; one diagram for each source or each temporal instant. This will likely reduce both the semantic transparency and plastic generativity of the representation because sequences of diagrams will have to be generated and interpreted. Dealing with multiple voltage sources does not adversely affect the Equations approach, because terms for several sources can be included in models consisting of simultaneous equations. However, for time varying components the Equations approach usually employs differential calculus. This makes the overall representation less semantically transparent and harder to manipulate, because of the addition of more representational machinery for differential equations that is well known to pose a particular conceptual challenge.
- *Alternating current (AC) circuits*. The existing algebraic approaches require the inclusion of trigonometry or imaginary numbers to analyse AC circuits, building upon the basic representational system. There are diagrammatic approaches for modelling AC circuits, such as phase plots, but these representations use a quite different format to AVOW diagrams. Thus, the detrimental effect on the representational characteristics of AVOW diagrams is likely to be greater than the effect on the Equations approach, because the basic format of AVOW diagrams cannot merely be augmented but must be combined with another representation.

The second contextual aspect that has implications for the analysis of the representational systems concerns the type of problem solving task addressed. Here, the task analysis and the experiment largely focussed upon quantitative analyses of circuit behaviour. Widening the range of problem solving tasks to encompass activities such as new circuit design and fault finding may differentially impact on how well the representations satisfy the six characteristics of effective representations. On the one hand, consider troubleshooting a network that has a break or a short circuit. Analysing these faults with AVOW diagrams does not change how the topology of the circuit is modelled but only changes the relative shapes and sizes of the component AVOW boxes. With the Equations approach the need to deliberately exclude the sub-network affected by the fault does change the circuit topology, which forces one to laboriously re-analyse the circuit from scratch. On the other hand, AVOW diagrams may be more laborious for certain aspects of design than the Equations approach. Selecting possible sets of values for components to meet given design parameters may be achieved by writing and algorithmically solving a set of simultaneous equations capturing those parameters. Whereas using AVOW diagrams is likely to require a heuristic approach involving the iterative drawing and re-drawing of diagrams to find values to meet the given constraints.

The overall implication of these considerations is that the evaluation of complex representational systems in terms of the present six characteristics, or other criteria, should be made

on the basis of a clearly delimited knowledge domain and a well-specified class (or classes) of problems. Establishing such a common context provides basis for meaningful comparison of different representational systems. This requirement parallels Larkin and Simon's (1987) prescription that the analysis of computational differences between alternative representational formats for problem solving should be based on representations that are informationally equivalent. For studies of advanced problem solving and conceptual learning the notion of informational equivalence should be broadened to encompass requirements of knowledge equivalence and task equivalence as bases for studies of complex representational systems.

6. Law Encoding Diagrams

AVOW diagrams constitute one class of LEDs. We are using LEDs to study the nature and role of representations in problem solving and learning, because they are an unusual, or "extreme case", in the world of representational systems. The contrast between the representational and cognitive properties of LEDs with conventional representations used in many domains, provides a good basis on which to investigate the nature of cognition with representational systems in complex knowledge rich domains.

The initial work with LEDs took the form of computational modelling of processes of scientific discovery (Cheng, 1996a; Cheng & Simon, 1995). It was argued that realistic models must employ representations equivalent to those used by the original scientists, if the models are to provide relevant insights into the processes of discovery. By building models with diagrammatic representations similar to those used by the original scientists, and comparing them with conventional algebra-based approaches, it was found that the right diagrammatic representation could substantially reduce the size of the problem space and hence make problem solving easier.

Although LEDs are external representations, they raise questions about the nature of the internal mental counterparts to the external diagrams, which have been highlighted by recent models of reasoning and problem solving (e.g., Zhang, 1997; Tabachneck-Schijf, Leonardo, & Simon, 1997). To address this issue in the context of LEDs, a framework of schemas for analysing cognition with LEDs has been proposed (Cheng, 1999b). The framework distinguishes knowledge in complex scientific domains along two dimensions: (i) theoretical relations and laws versus phenomenal cases and instances; (ii) basic intra-entity relations versus inter-component interactions. Thus, there are four classes of schemas, which are, for example, in the domain of electricity: (1) schemas for particular cases of basic entities (e.g., Table 1, Figs. A, D and E); (2) schemas for relations governing those entities (e.g., Power law, Ohm's law); (3) schemas for particular composites of components (e.g., Figs. B, C and D); (4) schemas for rules governing those composites (e.g., Kirchhoff's laws). Their utility for characterising learning with LEDs has been demonstrated by using it to analyse verbal and behavioural protocols of a participant learning to use AVOW diagrams (Cheng, 1998).

Computational modelling of learning and problem solving with AVOW diagrams is being done with CHREST+. This model extends Gobet and Simon's (1998) CHREST model of perceptual learning through the acquisition of perceptual chunks. CHREST+ demonstrates that some of the advantages of AVOW diagrams may be due to the encoding of specific diagrams

as perceptual chunks in long term memory, organised in the form of a discrimination network (Lane, Cheng, & Gobet 1999). Problem solving is modelled by linking particular nodes in a discrimination network for AVOW diagrams, which CHREST+ is learning, with equivalent nodes in a discrimination net for circuit diagrams, which CHREST+ is also learning. Given a target circuit, the system recognises particular sub-networks of loads, finds matching AVOW diagram chunks and draws them (Lane, Cheng, & Gobet, 2000). The chunks acquired and used by CHREST+ predict the chunks that human learners acquire when given the same sequence of target circuits and AVOW diagram solutions. This model holds some promise as a means to explore the merits and relative importance of the principles for effective representations presented here.

Previous studies of learning and instruction with LEDs focussed on the domain of particle collisions in physics. A computer-based discovery learning environment was built. Users of the system interactively manipulated LEDs on screen, with the program ensuring that the diagrams obeyed the constraints defining those LEDs which encode the laws of energy and momentum conservation (Cheng, 1996b, 1999a). The participants in the evaluations learned about the domain by comparing different configurations of the LEDs with an animated simulation of particle collisions. Undergraduate physicists and engineers were the participants in two studies. The first study demonstrated that after a 1 h session on the system, learners could use the LEDs for problem solving, adopting novel approaches to solve problems they were previously unable to handle using the algebraic laws of the domain with which they were familiar (Cheng, 1996b). The second experiment matched participants using the LED system with a group using an equivalent version of the system based on the conventional formulas and a non-intervention control group (Cheng, 1996c). It was found that only the LED system group showed an improvement in qualitative reasoning, which was explained by the greater range of different types of collisions that they were able to examine. A wider range of collisions provides a greater variety of configurations of the LEDs over which the participants can generalise in order to infer the correct constraints governing the LEDs. A better understanding of the constraints was correlated with gains in qualitative reasoning.

The present experiment with AVOW diagrams extends the previous studies in four ways. First, it provides an evaluation of LEDs in a new domain, which gives another example of how an alternative representation may be more effective than conventional approaches to science learning with equations. Electricity and particle collisions are both domains in which relatively complex relations govern diverse manifestations of a phenomenon. Instruction in domains with similar characteristics are likely to be amenable to an approach with LEDs.

Second, the participants in the previous studies were undergraduate physicists, who had some prior knowledge of the domain. This experiment shows that LEDs can be used to support learners who know little about the domain and to do better than the conventional Equations approach. The participants were not completely naive, as they were aware of such things as batteries and resistors. However, as shown by the recall test before instruction, their knowledge of anything but basic facts was superficial and fragmentary. At the delayed post-test, after about 100 min of instruction, the AVOW participants were all able to recall how AVOW boxes encode the relations among electrical properties and the rules for composite AVOW diagrams.

Third, the experiment demonstrates that LEDs can support learning in domains that not only deal with relations amongst entities, as in the previous work on particle collisions, but LEDs can

be effective for domains that also involve complex interactions amongst components at different levels within the domain. Managing multiple levels of constraints does not appear to pose a major problem to participants, as they were able to quickly draw and re-draw AVOW diagrams to obtain a legal diagram simultaneously satisfying all the constraints of the representational system and the requirements specified in a given problem.

Finally, by inventing a new representation and contrasting it with an extant representation by means of a task analysis and a learning experiment, six principles for representational systems to support effective conceptual learning in complex domains have been discovered.

Acknowledgments

This work was supported by the U.K. Economic and Social Research Council through the Centre for Research in Development, Instruction and Training. Thanks must go to all the members of CREDIT who assisted me in this work, and in particular to Nigel Pitt who ran the experiment, Peter Lane who critiqued the task analysis, David Wood for comments on an earlier draft of the paper, and Jo Cheng for proof reading. I am also grateful to Clayton Lewis, James Greeno, Steven Casner, Mitchell Nathan and Jiajie Zhang for their insightful comments that have greatly improved this paper, whilst noting that any limitations of the paper are due to me alone.

Appendix A. Equations mini-curriculum sample topic

A.1. Parallel resistors

Loads are connected side-by-side.

The current splits into two or three streams that flow through each load and then after get recombined.

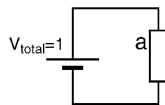
The voltage is the same across all the loads.

The total current, I , is the sum of all the individual currents.

Total resistance, R , is the reciprocal of the sum of the reciprocals of all the individual resistances.

Total resistance goes down as more resistors are added, whilst the overall power goes up.

One load

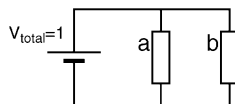


$$V_{\text{total}} = V_a$$

$$R_a = \frac{V_a}{I_a}$$

$$P_a = I_a \times V_a$$

Two loads in parallel



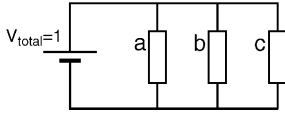
$$V_{\text{total}} = V_a = V_b$$

$$I_{\text{total}} = I_a + I_b = \frac{V}{R_a} + \frac{V}{R_b}$$

$$\frac{1}{R_{\text{total}}} = \frac{1}{R_a} + \frac{1}{R_b} = \frac{I_a}{V_a} + \frac{I_b}{V_b} = \frac{I_a + I_b}{V} \text{ or}$$

Appendix A (Continued)

Three loads
in parallel



$$R_{\text{total}} = \frac{R_a \times R_b}{R_a + R_b}$$

$$P_{\text{total}} = P_a + P_b = (I_a \times V) + (I_b \times V) \\ = V \times (I_a + I_b)$$

$$V_{\text{total}} = V_a = V_b = V_c$$

$$I_{\text{total}} = I_a + I_b + I_c = \frac{V}{R_a} + \frac{V}{R_b} + \frac{V}{R_c}$$

$$\frac{1}{R_{\text{total}}} = \frac{I_a}{V} + \frac{I_b}{V} + \frac{I_c}{V} = \frac{1}{R_a} + \frac{1}{R_b} + \frac{1}{R_c} \text{ or}$$

$$R_{\text{total}} = \frac{(R_a \times R_b) + (R_b \times R_c) + (R_c \times R_a)}{R_a + R_b + R_c}$$

$$P_{\text{total}} = P_a + P_b + P_c = (I_a \times V) + (I_b \times V) + (I_c \times V) \\ = V(I_a + I_b + I_c)$$

A.2. Parallel resistors with equal resistances

When the values of resistance are equal the current in each load is equal: $I_a = I_b = I_c$. The total current is shared equally among each load.

Appendix B. AVOW diagram mini-curriculum: sample topic

B.1. Parallel resistors

Loads are connected side-by-side—place AVOW boxes side-by-side.

The current splits into two or three streams that flow through each load and then after get recombined—put the AVOW boxes side-by-side.

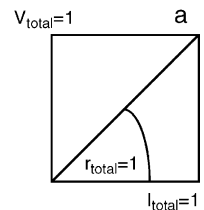
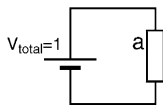
The voltage is the same across all the loads—make the AVOW box heights equal.

The total current, I_{total} is the width of the whole diagram.

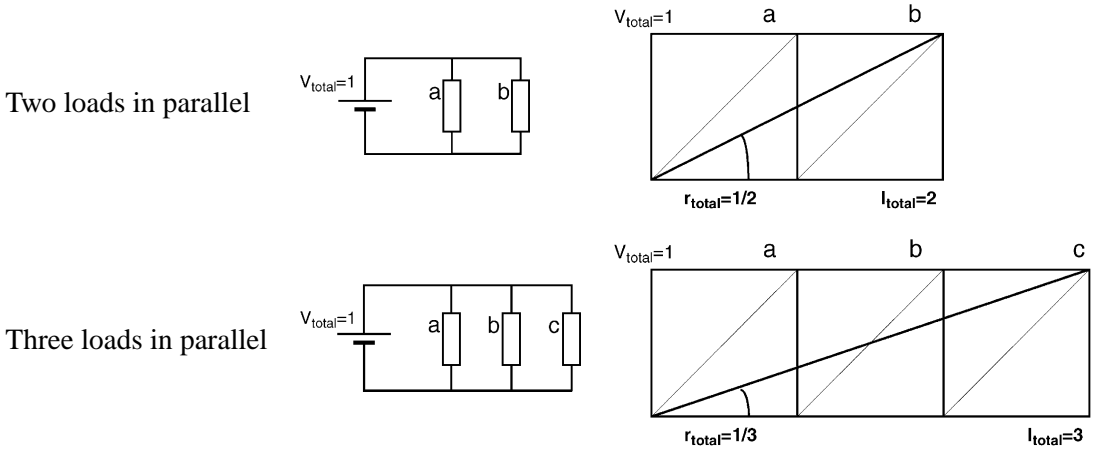
Total resistance, r_{total} , of all the loads is the gradient of the diagonal of the whole diagram.

Total resistance goes down as more resistors are added, whilst the overall power goes up.

One load

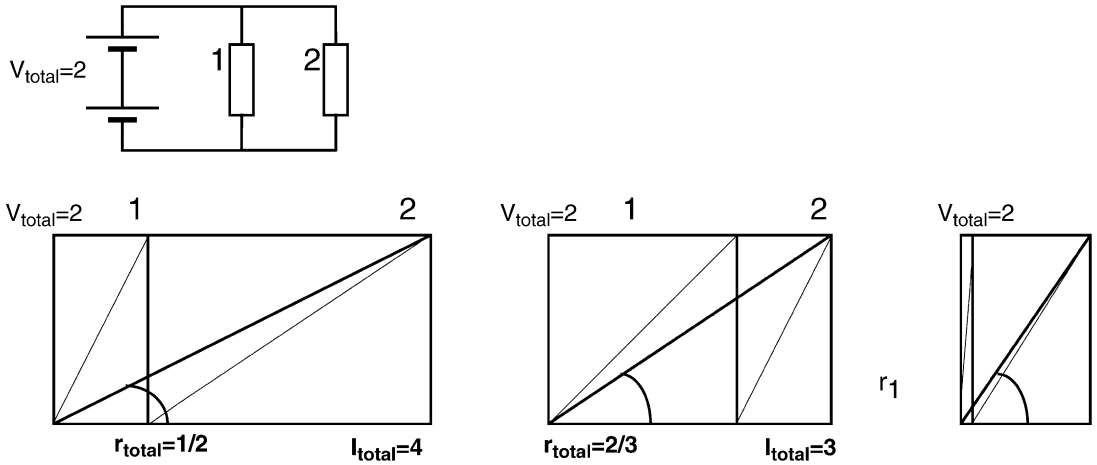


Appendix B (Continued)



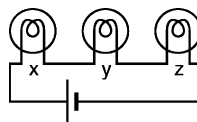
B.2. Parallel resistors with different resistances

Composite AVOW diagrams are always complete rectangles with no empty spaces.



Appendix C. Sample multiple-choice (MC) questions

C.1. Basic

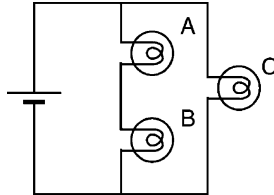


- (1) Which is/are the brightest of the three identical lamps in the circuit shown.
 (a) x (b) y (c) z (d) all equal* (e) x and z

C.2. Relations

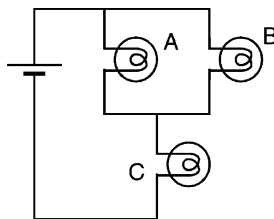
- (4) How much current (A) will flow through a radio speaker of $8\ \Omega$ resistance when 12 V is impressed across it?
 (a) 8 (b) 12 (c) 1.5^* (d) $2/3$ (e) $3/4$

C.3. Basic interaction



- (17) In this circuit how does the brightness of the identical bulbs compare?
 (a) $B = C$, A brightest
 (b) $A = C$, B dimmest
 (c) $A = B$, C dimmest
 (d) $A = B$, C brightest*
 (e) $A = B = C$

C.4. Complex interaction



- (24) In this circuit the bulbs are identical. What will happen to the brightness of bulbs B and C when bulb A is unscrewed?
 (a) no change in B and C
 (b) B brighter and C dimmer*
 (c) C brighter and B dimmer
 (d) C is brighter, B is the same
 (e) B is brighter, C is the same
 (e) B is brighter, C is the same
 (*) Correct answer.

References

- Bertin, J. (1983). *Seminology of graphics: Diagrams, networks, maps*. Wisconsin: University of Wisconsin Press.
 Breithaupt, J., & Dunn, K. (1983). *A level physics*. London: Letts Education.

- Carpenter, P. A., & Shah, P. (1998). A model of the perceptual and conceptual processes in graph comprehension. *Journal of Experimental Psychology: Applied*, 4(2), 75–100.
- Cheng, P. C.-H. (1996a). Scientific discovery with law encoding diagrams. *Creativity Research Journal*, 9(2/3), 145–162.
- Cheng, P. C.-H. (1996b). Law encoding diagrams for instructional systems. *Journal of Artificial Intelligence in Education*, 7(1), 33–74.
- Cheng, P. C.-H. (1996c). Learning qualitative relations in physics with law encoding diagrams. In G. W. Cottrell (Ed.), *Proceedings of the Eighteenth Annual Conference of the Cognitive Science Society* (pp. 512–517). Hillsdale, NJ: Lawrence Erlbaum.
- Cheng, P. C.-H. (1998). A framework for scientific reasoning with law encoding diagrams: Analysing protocols to assess its utility. In *Proceedings of the Twentieth Annual Conference of the Cognitive Science Society*. Hillsdale, NJ: Lawrence Erlbaum.
- Cheng, P. C.-H. (1999a). Interactive law encoding diagrams for learning and instruction. *Learning and Instruction*, 9(4), 309–326.
- Cheng, P. C.-H. (1999b). Networks of law encoding diagrams for understanding science. *European Journal of Psychology of Education*, 14(2), 167–184.
- Cheng, P. C.-H. (1999c). *Representational analysis and design: What makes an effective representation for learning probability theory?* (Technical Report No. 65). ESRC Centre for Research in Development, Instruction and Training.
- Cheng, P. C.-H. (1999d). Unlocking conceptual learning in mathematics and science with effective representational systems. *Computers in Education*, 33(2/3), 109–130.
- Cheng, P. C.-H. (2000). *Representations for problem solving in electricity: AVOW diagrams versus Equations* (Technical Report No. 68). ESRC Centre for Research in Development, Instruction and Training.
- Cheng, P. C.-H. (2001). AVOW diagrams: A novel representational system for understanding electricity. In M. Anderson, B. Meyer, & P. Olivier (Eds.), *Diagrammatic representation and reasoning* (pp. 512–534). Berlin: Springer.
- Cheng, P. C.-H., Barone, R., Cowling, P. I., & Ahmadi, S. (2002). Opening the information bottleneck in complex scheduling problems with a novel representation: STARK diagrams. In M. Hegarty, B. Meyer, & N. H. Narayanan (Eds.), *Diagrammatic representations and inference: Second International Conference, Diagrams 2002* (pp. 264–278). Berlin: Springer.
- Cheng, P. C.-H., & Pitt, N. G. (in press). Diagrams for difficult problems in probability. *Mathematical Gazette*.
- Cheng, P. C.-H., & Shipstone, D. M. (in press, a). Supporting learning and promoting conceptual change with box and AVOW diagrams. Part 1: Representational design and instructional approaches. *International Journal of Science Education*.
- Cheng, P. C.-H., & Shipstone, D. M. (in press, b). Supporting learning and promoting conceptual change with box and AVOW diagrams. Part 2: Their impact on student learning at A-level. *International Journal of Science Education*.
- Cheng, P. C.-H., & Simon, H. A. (1995). Scientific discovery and creative reasoning with diagrams. In S. Smith, T. Ward, & R. Finke (Eds.), *The creative cognition approach* (pp. 205–228). Cambridge, MA: MIT Press.
- Chi, M. T. H., Glaser, R., & Farr, M. J. (Eds.). (1988). *The nature of expertise*. Hillsdale, NJ: Lawrence Erlbaum.
- Cleveland, W. S., & McGill, R. (1985). Graphical perception and graphical methods for analysing scientific data. *Science*, 229, 828–833.
- Cohen, R., Eylon, B., & Ganiel, U. (1983). Potential difference and current in simple electric circuits: A study of students' concepts. *American Journal of Physics*, 51(5), 406–413.
- Duncan, T. (1973). *Advance physics: Material and mechanics*. London: John Murray.
- Ericsson, K. A., & Smith, J. (1991). *Toward a general theory of expertise*. Cambridge: Cambridge University Press.
- Glasgow, J. I., Narayanan, H., & Chandrasekaran, C. (Eds.). (1995). *Diagrammatic reasoning*. Cambridge, MA: AAAI/MIT Press.
- Gobet, F., & Simon, H. A. (1998). Expert chess memory: Revisiting the chunking hypothesis. *Memory*, 6(3), 225–255.
- Hewitt, P. G. (1992). *Conceptual physics* (7th ed.). New York, NY: Harper Collins.

- Koedinger, K. R., & Anderson, J. R. (1990). Abstract planning and perceptual chunks: Elements of expertise in geometry. *Cognitive Science*, 14, 511–550.
- Kosslyn, S. M. (1989). Understanding charts and graphs. *Applied Cognitive Psychology*, 3, 185–226.
- Kotovsky, K., Hayes, J. R., & Simon, H. A. (1985). Why are some problems hard? *Cognitive Psychology*, 17, 248–294.
- Larkin, J. H., & Simon, H. A. (1987). Why a diagram is (sometimes) worth ten thousand words. *Cognitive Science*, 11, 65–99.
- Lane, P. C. R., Cheng, P. C.-H., & Gobet, F. (1999). Learning perceptual schemas to avoid the utility problem. In M. Bramer, A. Macintosh, & F. Coenen (Eds.), *Research and development in intelligent systems XVI: Proceedings of ES99, the Nineteenth SGENS International Conference on Knowledge Based Systems and Applied Artificial Intelligence* (pp. 72–82). Cambridge, UK: Springer.
- Lane, P., Cheng, P. C.-H., & Gobet, F. (2000). CHREST+: How humans learn to solve problems using diagrams. *AISB Quarterly*, 103, 24–30.
- McDermott, L. C., & Shaffer, P. S. (1992). Research as a guide for curriculum development: An example from introductory electricity. Part I: Investigation of student understanding. *American Journal of Physics*, 60(11), 994–1003.
- Newell, A., & Simon, H. A. (1972). *Human problem solving*. Englewood Cliffs, NJ: Prentice-Hall.
- Palmer, S. E. (1978). Fundamental aspects of cognitive representation. In E. Rosch & B. B. Lloyd (Eds.), *Cognition and categorisation* (pp. 259–303). Hillsdale, NJ: Lawrence Erlbaum.
- Peterson, D. (Ed.). (1996). *Forms of representation*. Tunbridge Wells: Intellect.
- Pinker, S. (1990). A theory of graph comprehension. In R. Freedle (Ed.), *Artificial intelligence and the future of testing* (pp. 73–126). Hillsdale, NJ: Lawrence Erlbaum.
- Pople, S. (1996). *Advanced physics through diagrams*. Oxford: Oxford University Press.
- Shipstone, D. S., & Cheng, P. C.-H. (2001). Electric circuits: A new approach—part 1. *School Science Review*, 83(303), 55–63.
- Shipstone, D. M., & Cheng, P. C.-H. (2002). Electric circuits: A new approach—part 2. *School Science Review*, 83(304), 73–81.
- Stenning, K., & Oberlander, J. (1995). A cognitive theory of graphical and linguistic reasoning: Logic and implementation. *Cognitive Science*, 19(1), 97–140.
- Tabachneck-Schijf, H. J. M., Leonardo, A. M., & Simon, H. A. (1997). CaMeRa: A computational model of multiple representations. *Cognitive Science*, 21(3), 305–350.
- Zhang, J. (1997). The nature of external representations in problem solving. *Cognitive Science*, 21(2), 179–217.
- Zhang, J., & Norman, D. A. (1994). Representations in distributed cognition tasks. *Cognitive Science*, 18(1), 87–122.